

V-Commande à courroie PJ VR-			
Type	Di	Da	force portante C [daN]
50x1,5.40	47,3	49,8	80

Courroies d'entraînement disponibles sur demande

- ☛ Boitier: plastique
- ☛ Labyrinthe simple: plastique
- ☛ Palier 6202
aussi avec 2 roulements à billes livrable

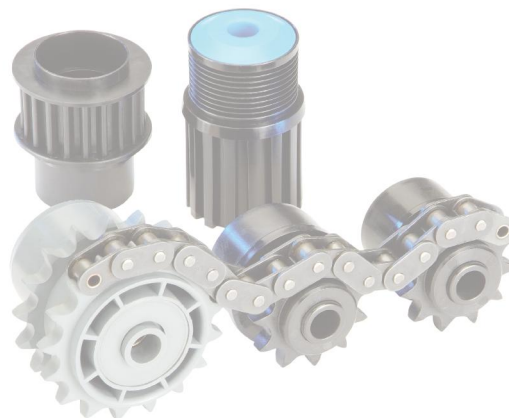

VR-40

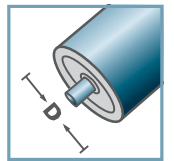

D [mm]
50

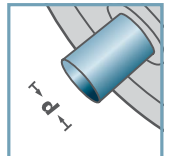

d [mm]
12; SW11



C [daN]
-

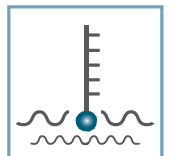

T [°C]
0° - 80°



EP 2



Carton [pc.]

100

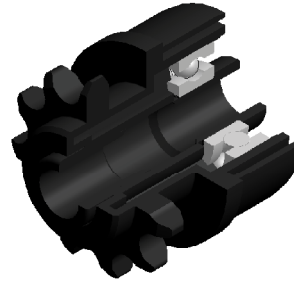
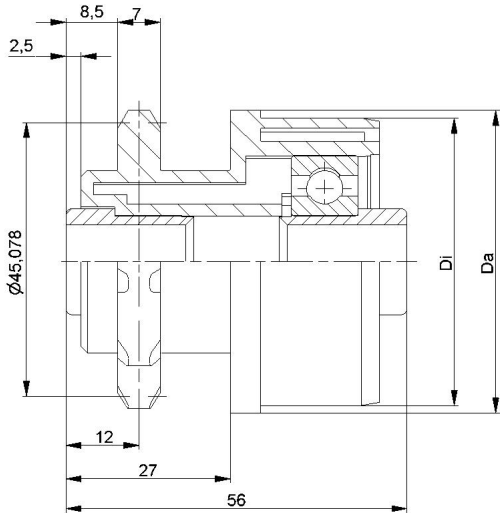

KKR-1/2" x5/16" -Z11 pour entraînement fixe

Type	Di +0,2	Da
50x1,5.40	47,3	49,9
50x2,8.40	44,6	49,9

Des dimensions ultérieures sur demande!

- ☛ Boîtier: plastique
- ☛ Douille de réduction: plastique
- ☛ Palier 6202

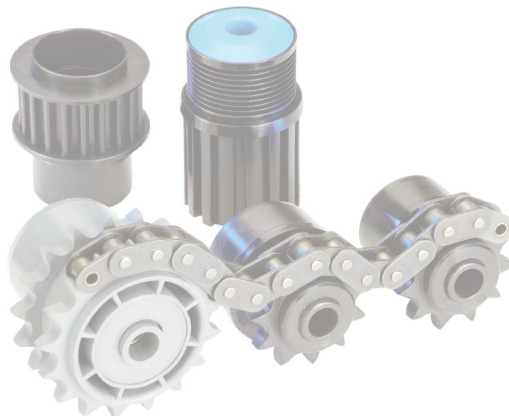

KKR-40

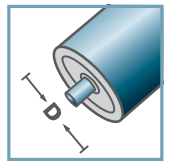

D [mm]
50

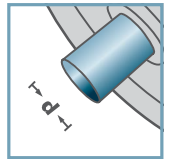

d [mm]
12



C [daN]
-

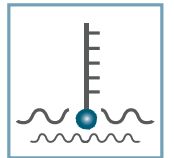

T [°C]
0° - 80°



EP 2



Carton [pc.]

150

Embout entraîne par pignon

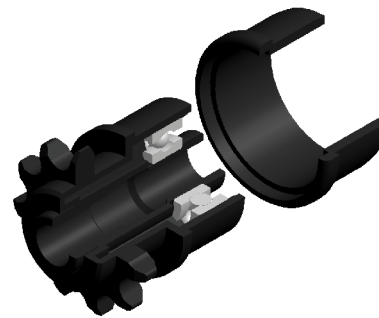
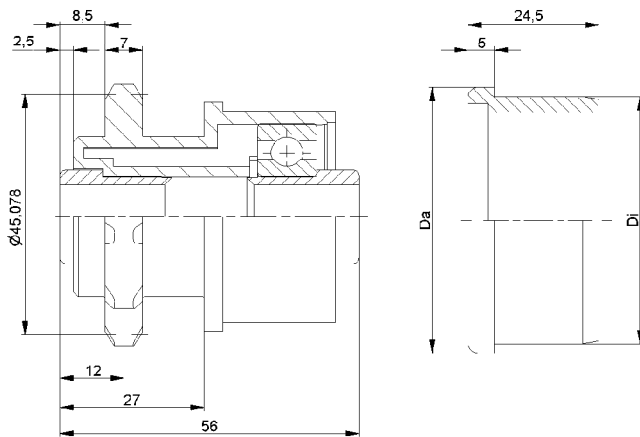

KKR-1/2" x5/16" -Z11 pour entraînement friction

Type	Di +0,2	Da
50x1,5.40 ST	47,3	49,9

Des dimensions ultérieures sur demande!

- ☛ Boîtier: plastique
- ☛ Douille de réduction: plastique
- ☛ Anneau de glissement: plastique
- ☛ Palier 6202

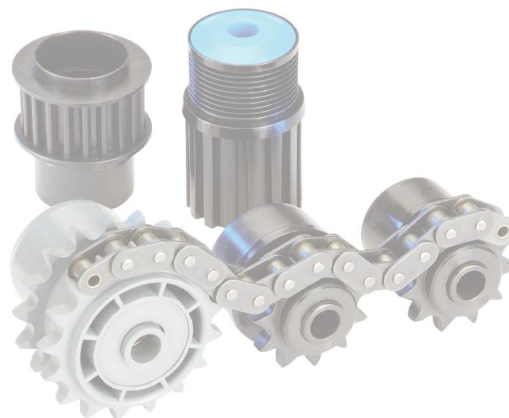

KKR-40

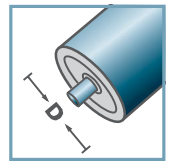

D [mm]
50

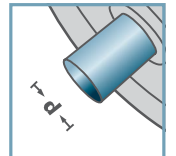

d [mm]
12



C [daN]
-

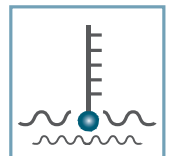

T [°C]
0° - 80°



EP 2



Carton [pc.]

Boîtier:
150
Anneau de
Glissement:
300

Embout entraîne par pignon

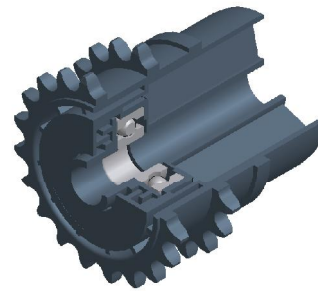
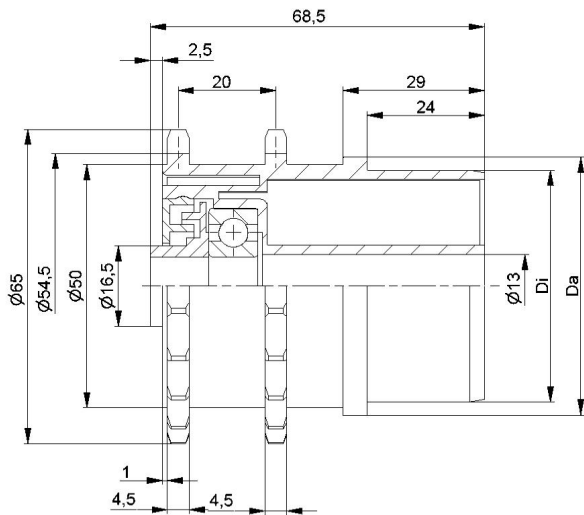

KKR-3/8" x3/16" -Z20		
Type	Di +0,2	Da
53x3,0.41	47,6	52,9

Des dimensions ultérieures sur demande!

- ☛ Boitier: plastique
- ☛ Labyrinthe intérieur: plastique
- ☛ Labyrinthe extérieur: plastique
- ☛ Palier 6201

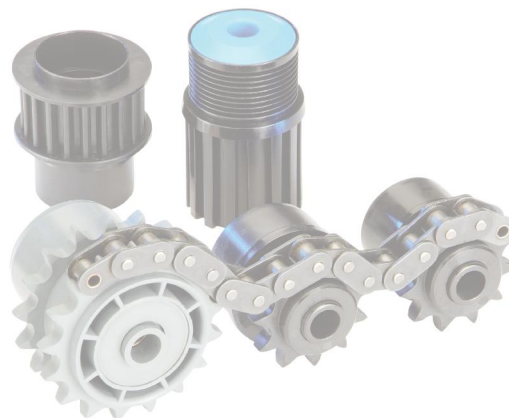

KKR-41

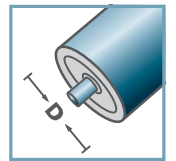

D [mm]
53

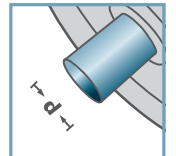

d [mm]
12



C [daN]
-

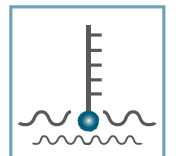

T [°C]
0° - 80°



EP 2



Carton [pc.]

60

Embout entraine par pignon

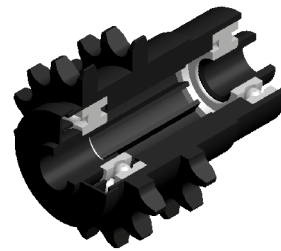
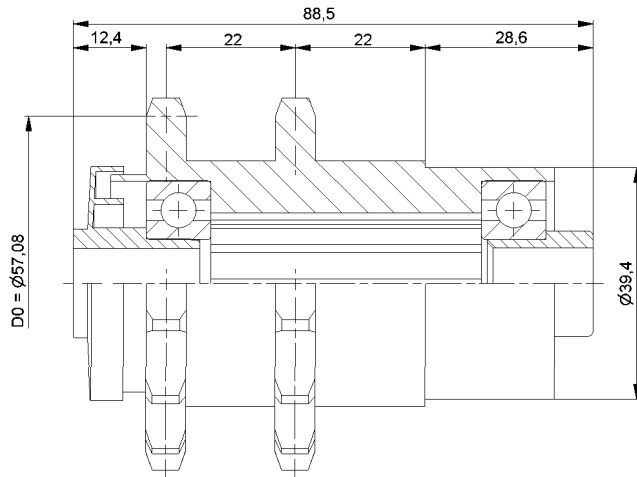

KKR-1/2" x5/16" -Z14

Des dimensions ultérieures sur demande!

- ☛ Boîtier: plastique
- ☛ Labyrinthe: plastique
- ☛ Douille de réduction: plastique
- ☛ Palier 6202

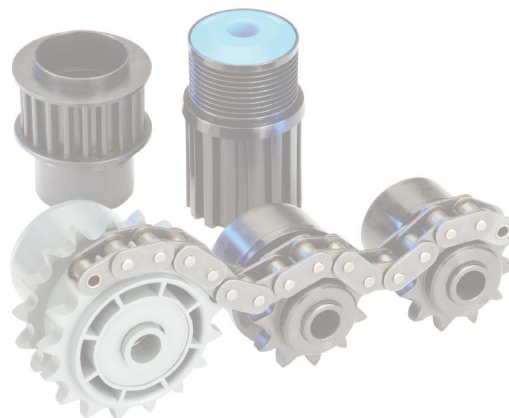

KKR-40

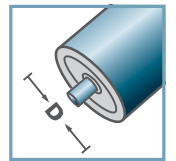

D [mm]

-

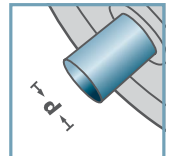

d [mm]

12



C [daN]

-

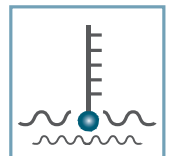

T [°C]

0° - 80°



-



Carton [pc.]

150

Embout entraine par pignon

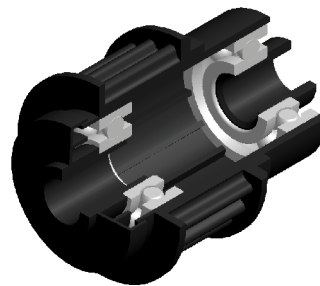
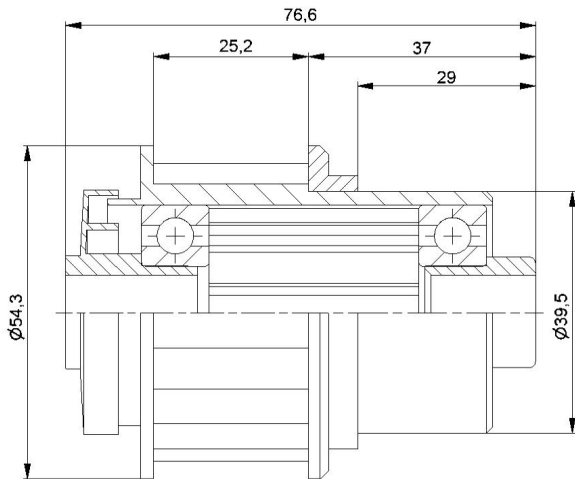

KZA-Z20.40

Des dimensions ultérieures sur demande!

- ☛ Boîtier: plastique
- ☛ Labyrinthe: plastique
- ☛ Douille de réduction: plastique
- ☛ Palier 6202

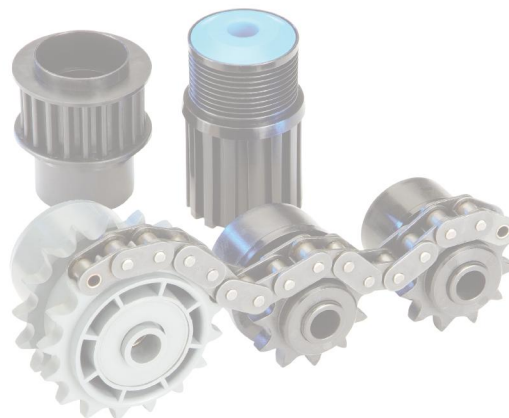

KZA-40

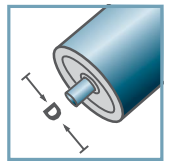

D [mm]

-

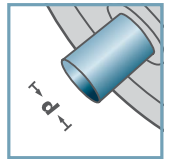

d [mm]

12



C [daN]

-

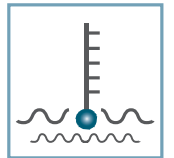

T [°C]

0° - 80°



-



Carton [pc.]

100

Entraînements par courroie crantée