

ASR-			
Typ	D	B	Tragzahl C [daN]
ASR-80	80	64	40

Weitere Varianten auf Anfrage!

- Radkörper: Kunststoff
- Tonnenrolle: Kunststoff
- Achse: 1.4301

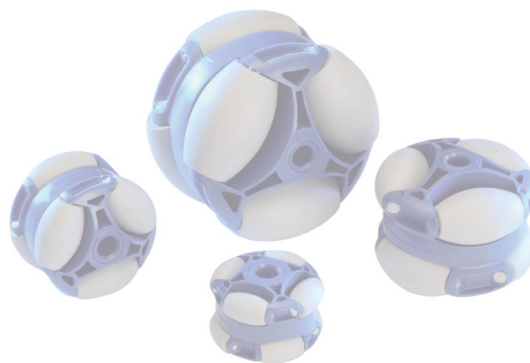

ASR-

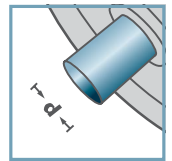

d [mm]
8; 12; 15; SW14



C [daN]
40

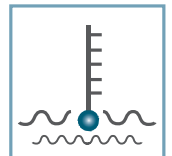

T [°C]
0° - 80°



-



Karton [Stck.]

50

Allseitenrollen

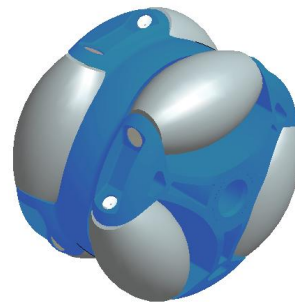
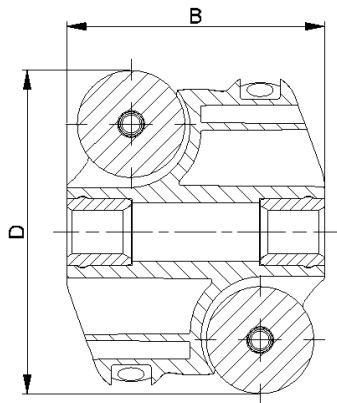

ASR-

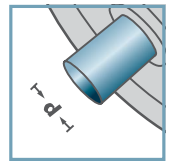

d [mm]
8; 10; SW9



C [daN]
10 - 20

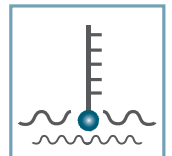

T [°C]
0° - 80°



ASR-			
Typ	D	B	Tragzahl C [daN]
ASR-60	60	48	20
ASR-48	48	39	15
ASR-40	40	29	10

Weitere Varianten auf Anfrage!

- ☛ Radkörper: Kunststoff
- ☛ Tonnenrolle: Kunststoff
- ☛ Achse: 1.4301

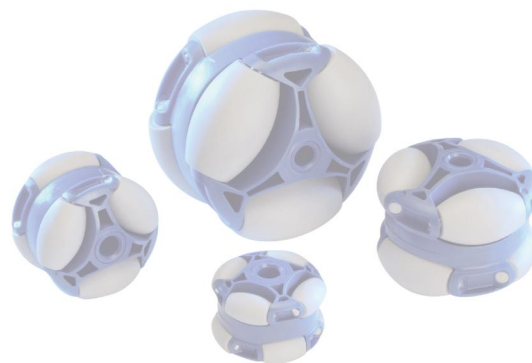

Karton [Stck.]

50

Allseitenrollen

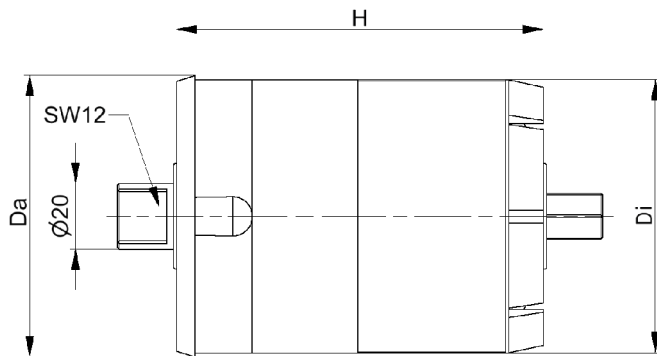
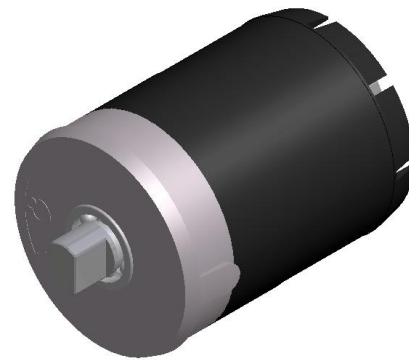

BR-89x3,0-				
Typ	Da	Di	H	Palette max. [kg]
200	88,5	83	115	200
500	88,5	83	115	500
800	88,5	83	115	800
1200	88,5	83	115	1200

Bremsrolleneinsatz



BR-

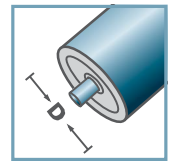

D [mm]
89

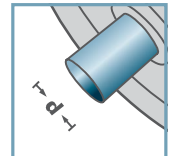

d [mm]
20



C [daN]
250

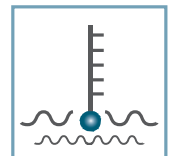

T [°C]
0° - 80°



EP2



Karton [Stck.]

20

Bremsrollen

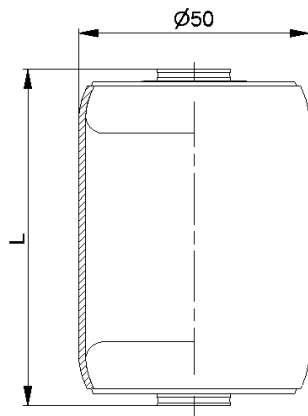

AMR-50x1,5.20		
Typ	L	Tragzahl C [daN]
AMR-50x1,5.20-66	66	160
AMR-50x1,5.20-73	73	160
AMR-50x1,5.20-80	80	160
AMR-50x1,5.20-100	100	160

Weitere Varianten auf Anfrage!

- ☛ Rohr: Stahl, verzinkt
- ☛ Metalltragrollenlager MTR-20



AMR-50.20

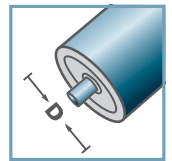

D [mm]
50

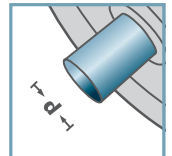

d [mm]
8; 10; 12; SW11



C [daN]
160

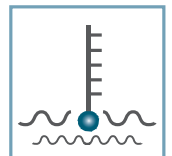

T [°C]
0° - 100°



Öl



Karton [Stck.]

Achslose Kurzrollen

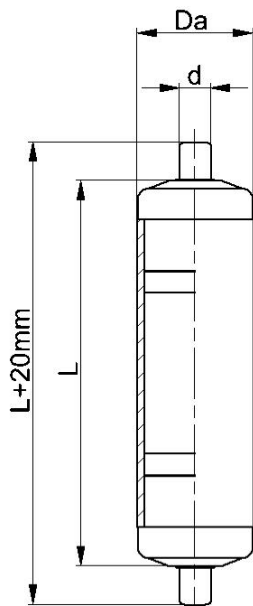

AKR-00/01

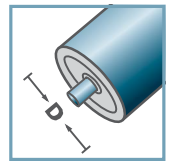

D [mm]
20; 30; 40

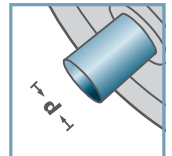

d [mm]
6; 8



C [daN]
10; 15

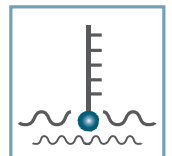

T [°C]
0° - 80°



AKR-00/01				
Typ	D	d	L max.	Tragzahl C [daN]
AKR-20x1,5.00.L	20	6	300	10
AKR-30x1,8.00.L	30	8	400	15
AKR-40x2,3.00.L	40	8	400	15
Weitere Varianten auf Anfrage!				

- ☛ Rohr: Kunststoff
- ☛ Kunststoffrollenlager KTR-00/01 mit Federachse



Karton [Stck.]

Achslose Kunststoffrollen mit Federachse