

SLR	
Type	Load Rating C [daN]
SLR-480	20
Other dimensions on request!	

Skate Wheel: Steel

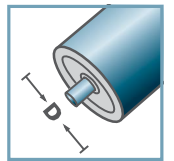

SLR-



D [mm]
-

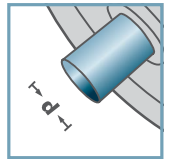

d [mm]
6; 8



C [daN]
20

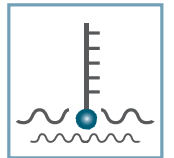

T [°C]
-30° - 140°



-



Carton [pcs.]

250

KLR/SLR/SR

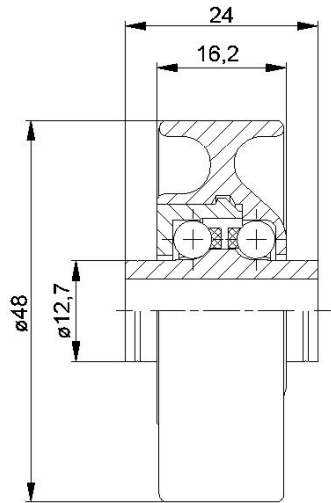

KLR-02/03			
Type	Normal .02	Stainless .03	Load Rating C [daN]
KLR-480	x	x	15

Other dimensions on request!

- ☛ Housing: Plastic
- ☛ Inner Race: Plastic
- ☛ Bearing Cap: Plastic
- ☛ Ball Cage: Plastic
- ☛ Ball
 - ☛ 02: Steel
 - ☛ 03: 1.4034



KLR-02
KLR-03

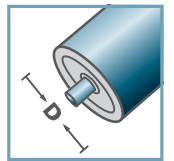

D [mm]
-

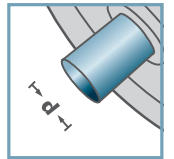

d [mm]
6; 8



C [daN]
15

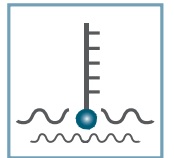

T [°C]
0° - 80°



-



Carton [pcs.]

250

KLR/SLR/SR

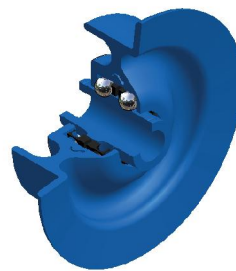
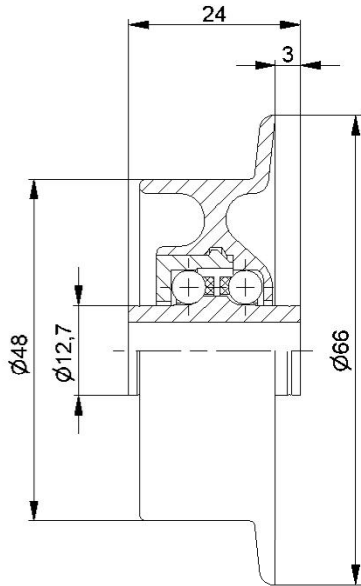

SR-02/03			
Type	Normal .02	Stainless .03	Load Rating C [daN]
SR-480	x	x	10

Other dimensions on request!

- ☛ Housing: Plastic
- ☛ Inner Race: Plastic
- ☛ Bearing Cap: Plastic
- ☛ Ball Cage: Plastic
- ☛ Ball
 - ☛ 02: Steel
 - ☛ 03: 1.4034



SR-02
SR-03

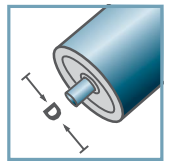

D [mm]
-

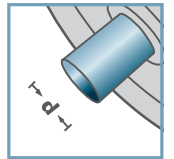

d [mm]
6; 8



C [daN]
15

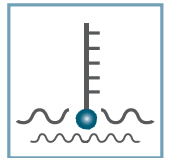

T [°C]
0° - 80°



-



Carton [pcs.]

250

KLR/SLR/SR

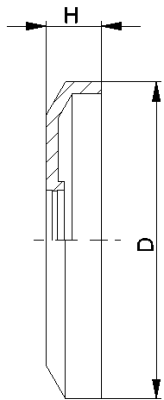

DK-KLR		
Type	D	H
DK-KLR-02	40,5	7
Other dimensions on request!		

Seal Bonnet: Plastic



DK-KLR-02

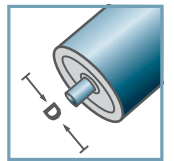

D [mm]
-

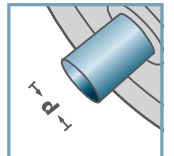

d [mm]
-



C [daN]
-

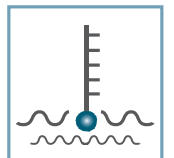

T [°C]
0° - 80°



-



Carton [pcs.]



KLR/SLR/SR