

LH-6204

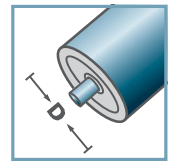

D [mm]
63,5 - 133

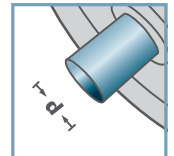

d [mm]
20



C [daN]
-

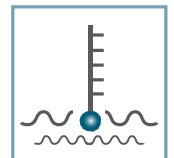

T [°C]
-



6204:
D47, d20, H14

LH-6204				
Type	Di	H	dL	t
LH-63,5x1,75/6204	60,5	33	26	1,5
LH-63,5x2,9/6204	58,2	33	26	1,5
LH-80x2,0/6204	76,5	36,5	26	2,0
LH-80x3,0/6204	74,5	36,5	26	2,0
LH-89x3,0/6204	83,5	36,5	26	2,0
LH-108x2,5/6204	103,3	36,5	26	2,0
LH-108x2,9/6204	102,8	36,5	26	2,0
LH-108x3,25/6204	102,1	36,5	26	2,0
LH-133x3,6/6204	126,3	36,5	26	2,5

Other dimensions on request!

Retainer for Standard Bearings: Steel

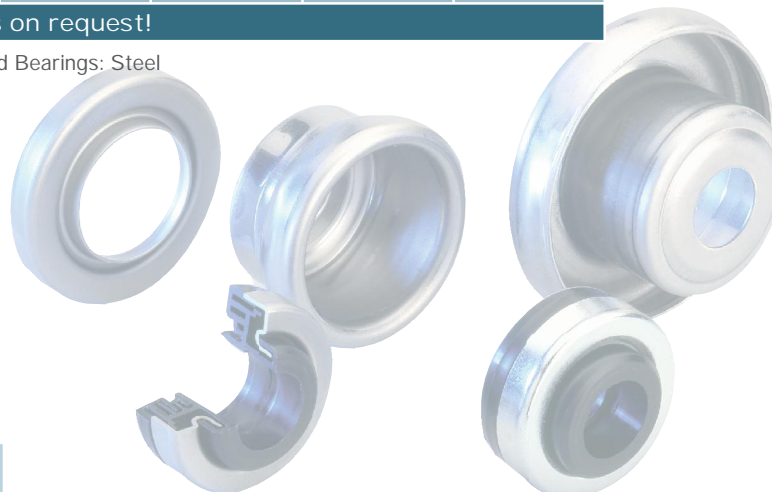

Skeleton Container [pcs.]
 ø63,5: 6000
 ø80: 3500
 ø89: 3100
 ø108: 2000
 ø133: 1150

LH/FL

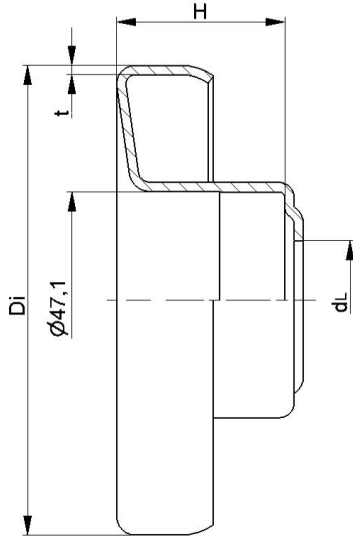

LH-6204 N

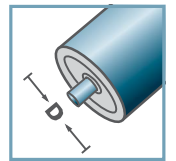

D [mm]
63,5 - 108

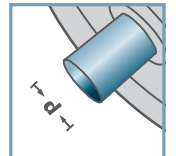

d [mm]
20



C [daN]
-

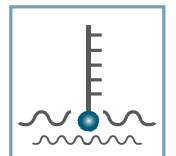

T [°C]
-



6204:
D47, d20, H14



Skeleton
Container [pcs.]
ø63,5: 6000
ø89: 3100/3350
ø108: 2000

LH-6204 N				
Type	Di	H	dL	t
LH-63,5x1,75/6204N	60,5	31,8	21	1,5
LH-89x3,0/6204N *	83,7	33,5	21	1,5
LH-108x3,25/6204N	102,1	36,5	21	2,0

Other dimensions on request!

☛ Retainer for Standard Bearings: Steel

☛ *Alternative: Stainless

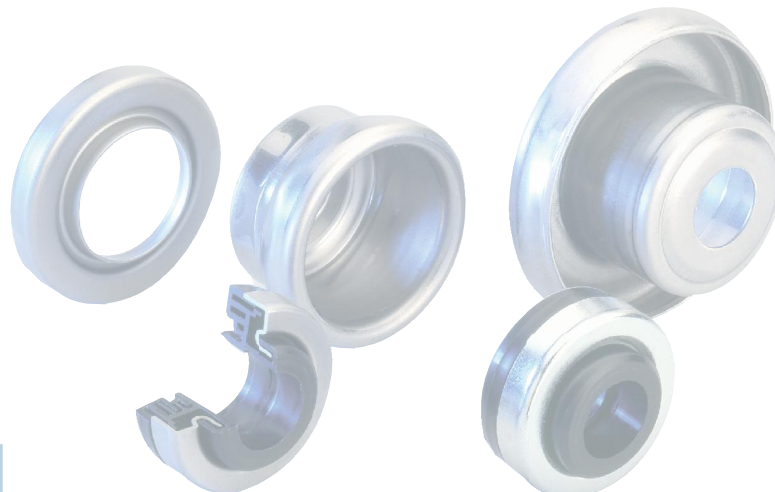

LH/FL

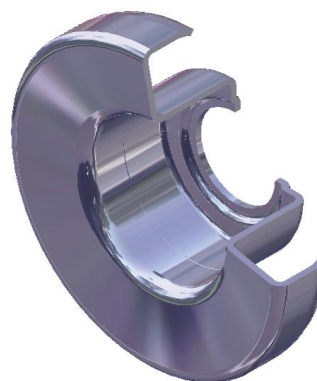
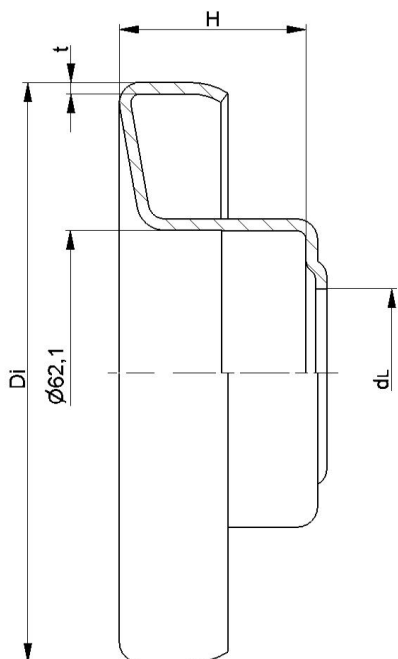

LH-6305

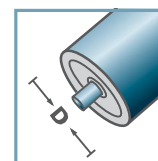

D [mm]
89 - 159

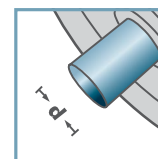

d [mm]
25

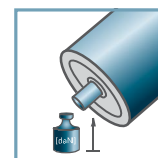

C [daN]
-

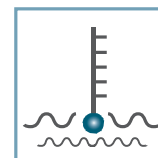

T [°C]
-



6305:
D62, d25, H17



Skeleton
Container [pcs.]
ø89: 2600
ø108: 1900
ø133: 1150

LH-6305				
Type	Di	H	dL	t
LH-89x3,0/6305	83,5	40,5	36,5	2,0
LH-108x2,5/6305	103,3	40,5	36,5	2,0
LH-108x3,25/6305	102,1	40,5	36,5	2,0
LH-127x2,9/6305	121,7	40,5	36,5	2,5
LH-133x3,6/6305	126,3	40,5	36,5	2,5
LH-159x4,5/6305	150,5	40,5	36,5	2,5

Other dimensions on request!

Retainer for Standard Bearings: Steel

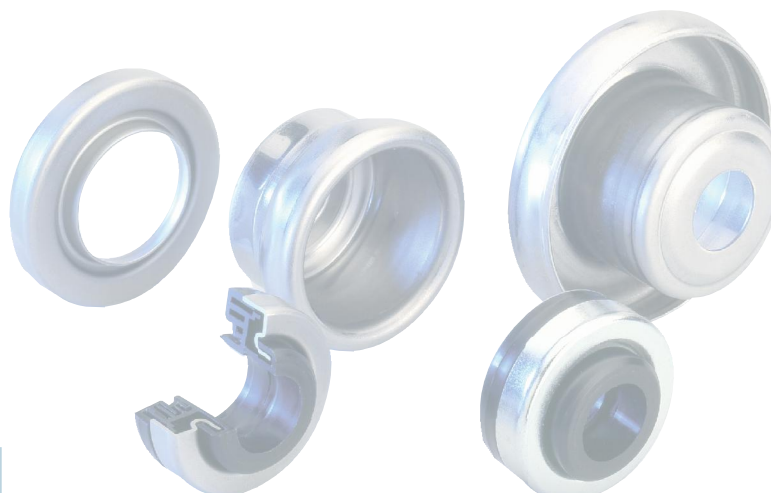

LH/FL

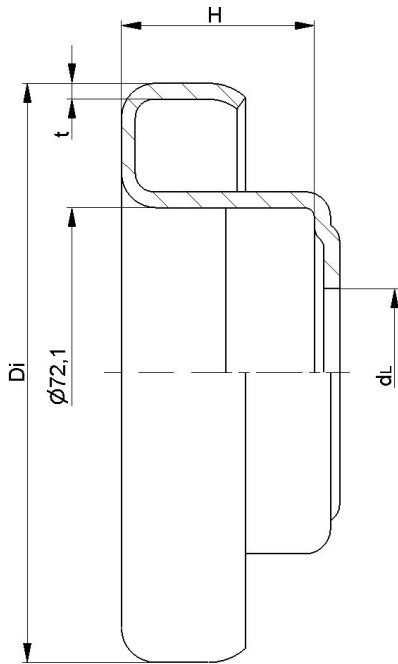

LH-6306				
Type	Di	H	dL	t
LH-108x3,25/6306	102,1	42	36,5	3,0
LH-133x3,6/6306	126,3	42	36,5	3,5
LH-159x4,5/6306	150,5	42	36,5	2,5

Other dimensions on request!

Retainer for Standard Bearings: Steel

LH-6306

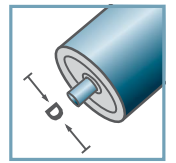

D [mm]
108 - 159

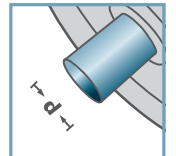

d [mm]
30



C [daN]
-

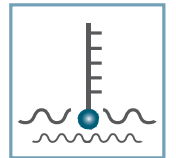

T [°C]
-



6306:
D72, d30, H19



Skeleton
Container [pcs.]
ø108: 1700
ø133: 1000

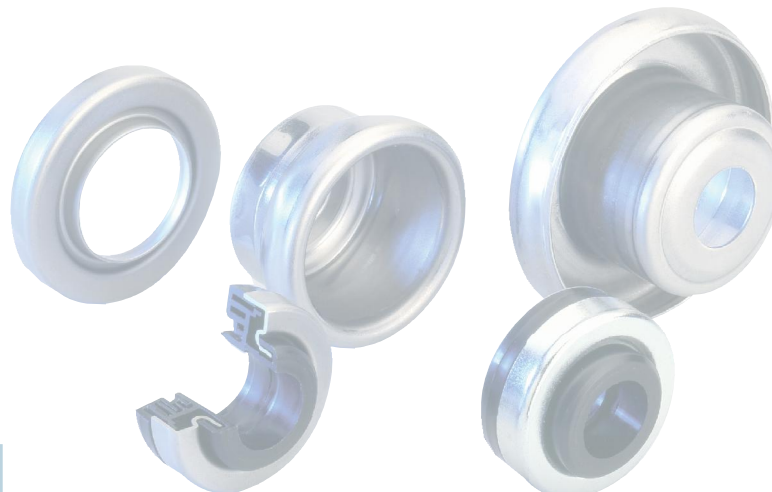

LH/FL

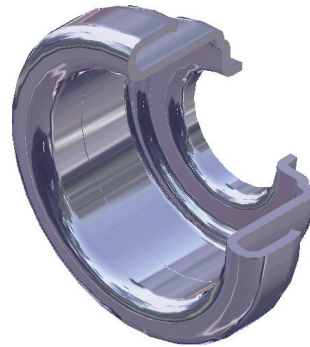
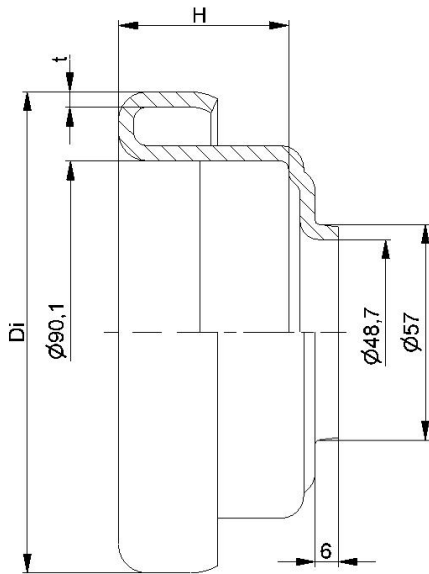

LH-6308			
Type	Di	H	t
LH-133x3,6/6308	126,3	44,6	4,0
LH-159x4,5/6308	150,8	44,6	4,0

Other dimensions on request!

Retainer for Standard Bearings: Steel

LH-6308

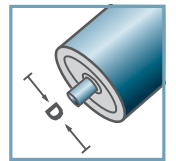

D [mm]
133 - 159

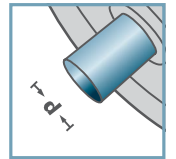

d [mm]
40



C [daN]
-

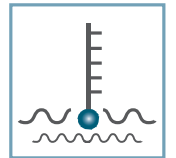

T [°C]
-



6308:
D90, d40, H23



Skeleton
Container [pcs.]
ø133: 800
ø159: 600

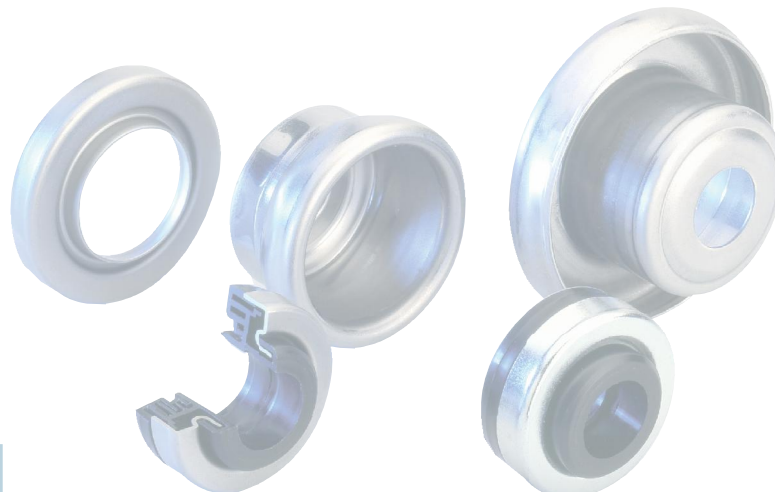

LH/FL

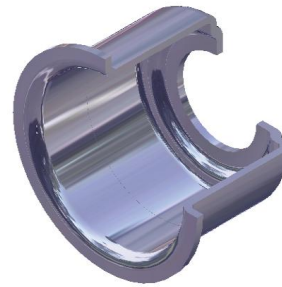
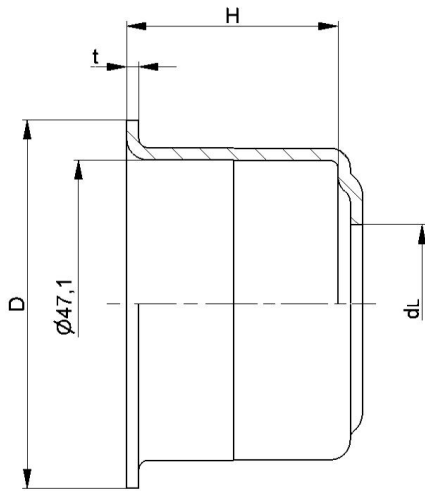

FL-6204

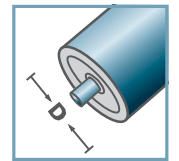

D [mm]
60 - 76

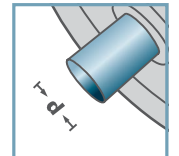

d [mm]
20



C [daN]
-

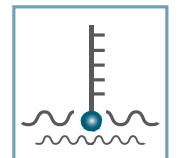

T [°C]
-



6204:
D47, d20, H14



Skeleton
Container [pcs.]
ø60: 4000
ø63,5: 4000
ø70: 2000
ø76: 2000

FL-6204				
Type	D	H	dL	t
FL-60x3,0/6204	58,1	34	26	2,0
FL-63,5x2,9/6204	60,0	34,5	26	2,0
FL-76/6204	73,5	34,5	26	2,0

Other dimensions on request!

Retainer for Standard Bearings: Steel

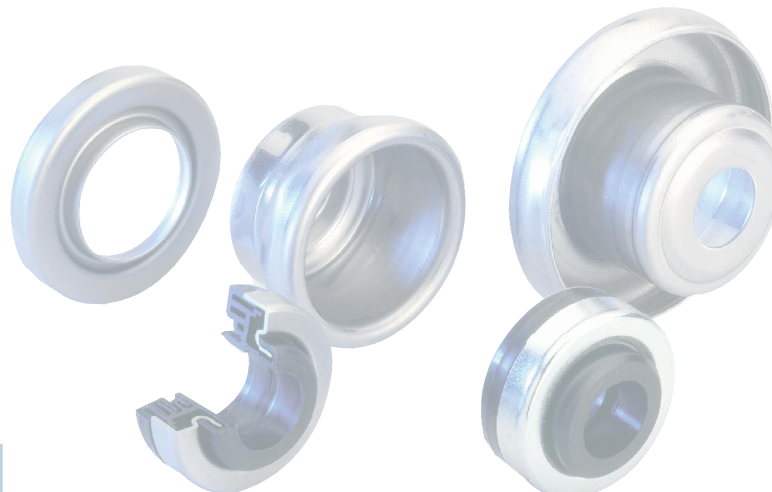

LH/FL

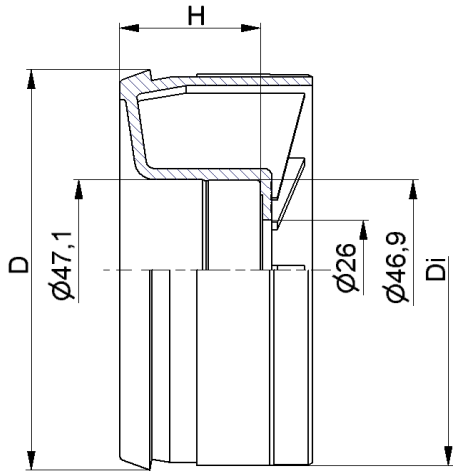

KLH-6204			
Type	Di	H	D
KLH-89x3,0/6204	83,2	36,5	85,3
KLH-108x3,0/6204	102,2	36,5	104,3

Other dimensions on request!

Retainer for Standard Bearings: Plastic

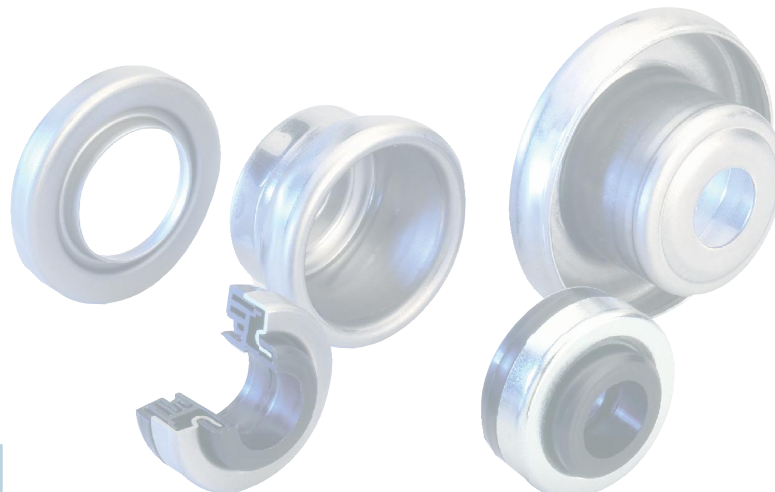

KLH-6204

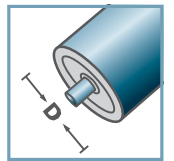

D [mm]
89 - 108

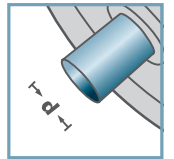

d [mm]
20



C [daN]
-

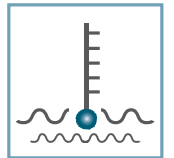

T [°C]
100°



6204:
D47, d20, H14



Skeleton
Container [pcs.]
1000

LH/FL

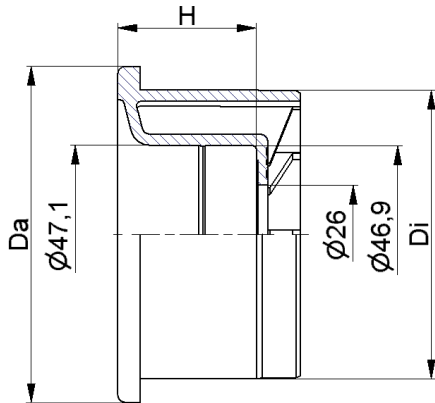

KLH-6204			
Type	Da	Di	H
KLH-90x7,0/6204	88,8	76,3	36,5

Other dimensions on request!

Retainer for Standard Bearings: Plastic

KLH-6204

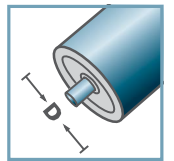

D [mm]
90

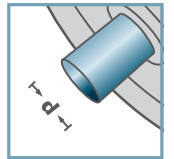

d [mm]
20



C [daN]
-

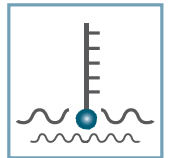

T [°C]
100°



6204:
D47, d20, H14



Skeleton
Container [pcs.]
1000

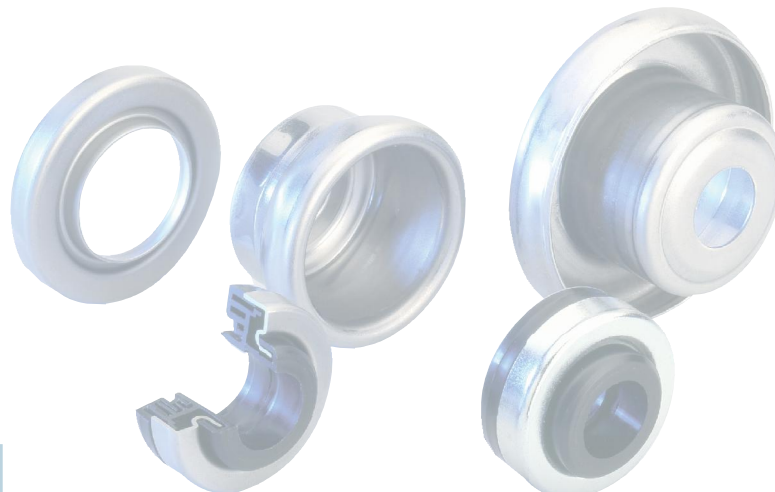

LH/FL

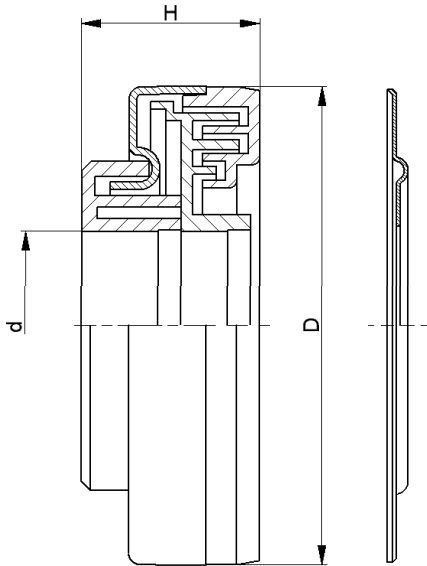

LH-

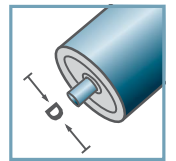

D [mm]

-

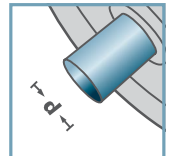

d [mm]

17 - 40



C [daN]

-

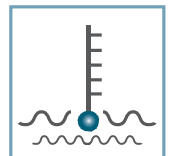

T [°C]

0° - 80°



-



Carton [pcs.]

6204: 500
6305: 500

LH-			
Type	D	H	d
LH-6303	47	22,5	17
LH-6204	47	22,5	20
LH-6204 N	47	20,0	20
LH-6305	62	23,5	25
LH-6206	62	23,5	30
LH-6306	72	24,5	30
LH-6308	90	23,1	40

Other dimensions on request!

- ☛ Seal Bonnet: Steel, Zinc plated
- ☛ Rain Cap: Plastic
- ☛ Inner Labyrinth Seal: Plastic
- ☛ Outer Labyrinth Seal: Plastic
- ☛ Sheet Gasket: Steel, Zinc plated
(not available with 6306 and 6308)

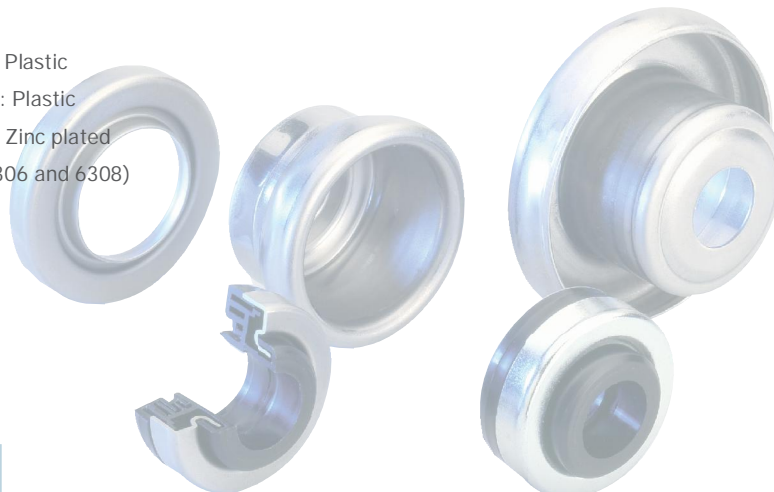

LH/FL

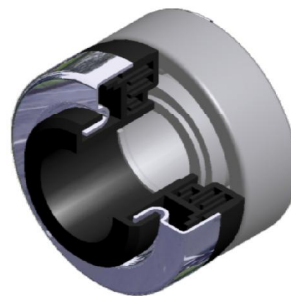
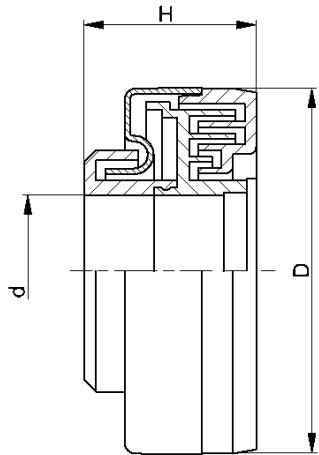

LH- mounted, greased			
Type	D	H	d
LH-6303 M	47	22,5	17
LH-6204 M	47	22,5	20
LH-6305 M	62	23,5	25
LH-6308 M	90	23,1	40

Other dimensions on request!

- ☛ Seal Bonnet: Steel, Zinc plated
- ☛ Rain Cap: Plastic
- ☛ Inner Labyrinth Seal: Plastic
- ☛ Outer Labyrinth Seal: Plastic
- ☛ Grease: EP2

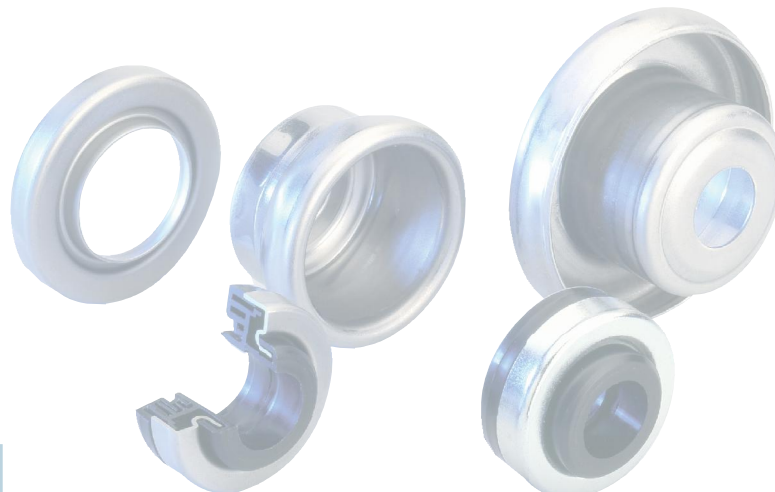

LH-

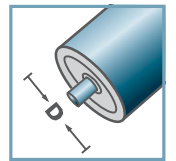

D [mm]

-

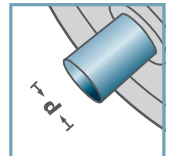

d [mm]
17, 20



C [daN]

-

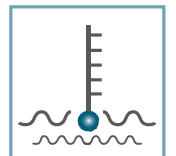

T [°C]
0° - 80°



-



Carton [pcs.]



LH/FL

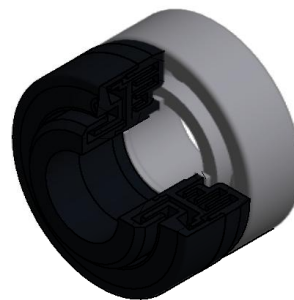
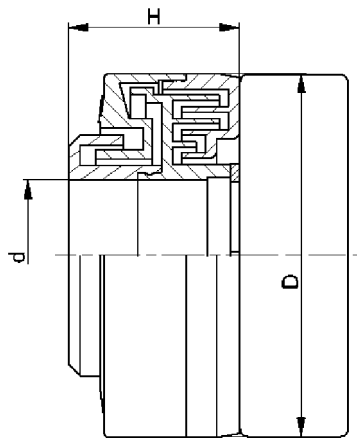

LH-			
Type	D	H	d
LH-6303 KU	47	22,5	17
LH-6204 KU	47	22,5	20

Other dimensions on request!

- ☛ Seal Bonnet: Plastic
- ☛ Rain Cap: Plastic
- ☛ Inner Labyrinth Seal: Plastic
- ☛ Outer Labyrinth Seal: Plastic

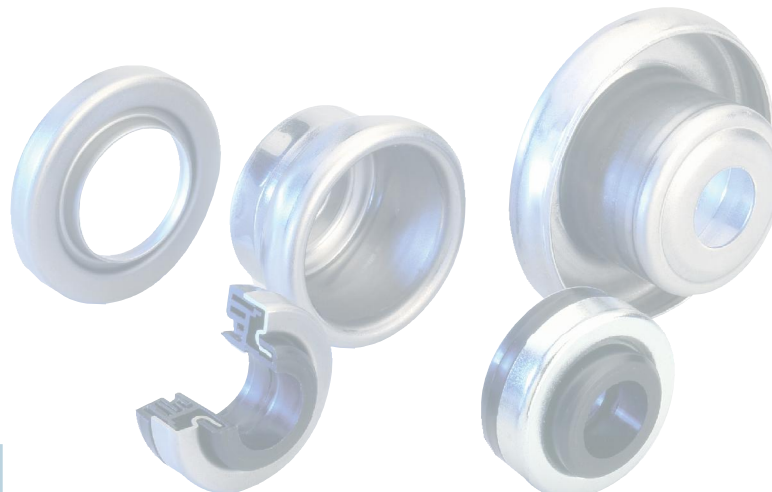

LH-

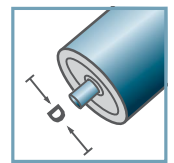

D [mm]

-

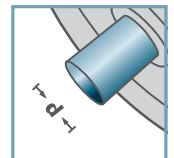

d [mm]
20



C [daN]

-

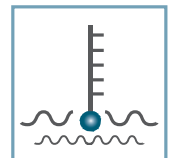

T [°C]
0° - 80°



-



Carton [pcs.]



LH/FL

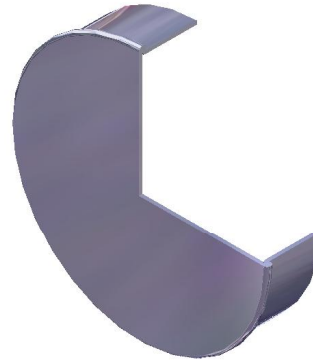
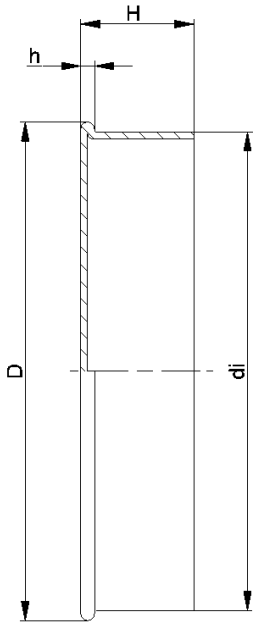

LH- closed				
Type	D	di	H	h
LH-6204	50	47,4	14,7	1,8

Other dimensions on request!

🔩 Seal Bonnet: Steel

LH-

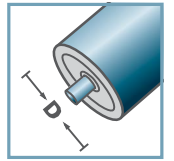

D [mm]
-

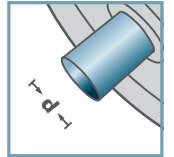

d [mm]
-



C [daN]
-

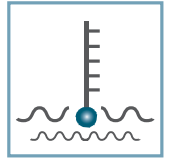

T [°C]
-



-



Carton [pcs.]

ST-6204 125
ST-6305 100
ST-6306 100

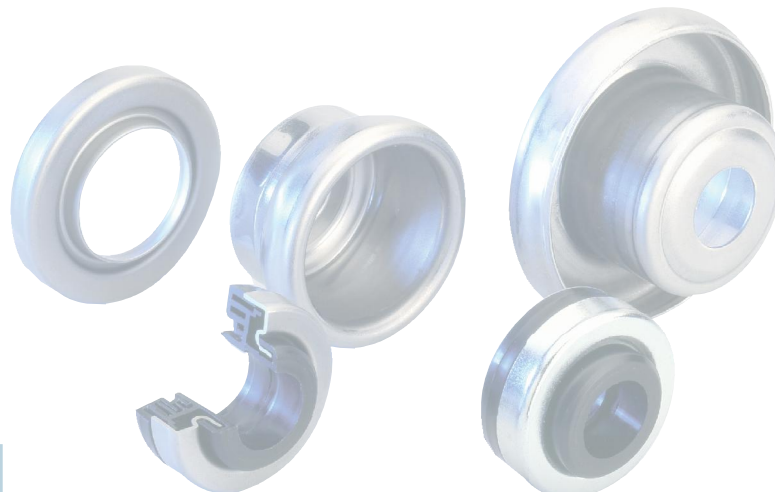

LH/FL

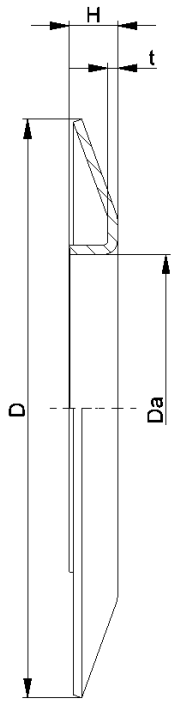

BS-				
Type	Da ±0.1	D -2	H ±0.5	t
BS-50-130	49,9	130	10	1,5
BS-60-130	59,9	130	10	1,5
BS-80-150	79,9	150	14	2,5
BS-89-150	88,9	150	14	2,5
BS-108-150	107,9	150	14	2,5

Other dimensions on request!

• Wheel Flange: Steel

BS-

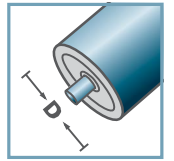

D [mm]
-

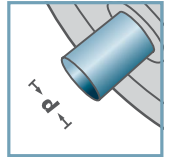

d [mm]
-



C [daN]
-

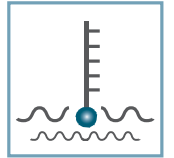

T [°C]
-



-



Carton [pcs.]

25

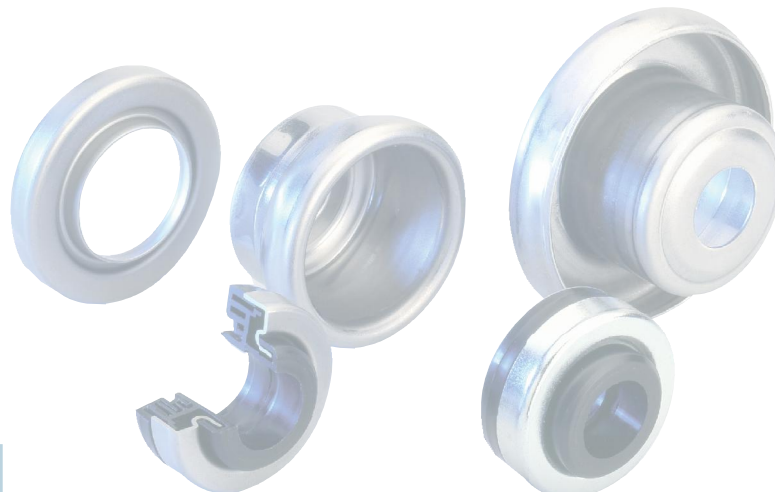

LH/FL