

VR-		
Type	Di	Da
50x1,5.40	47,3	49,8

Driving belt available on request!

Housing: Plastic



VR-40

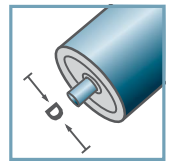

D [mm]
50

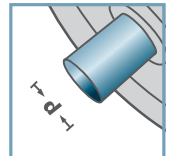

d [mm]
-



C [daN]
-

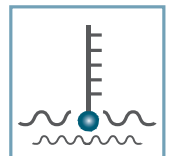

T [°C]
0° - 80°



-



Carton [pcs.]

100

Plastic VR-Belt Drive Wheel

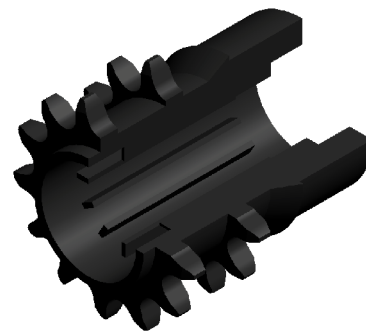
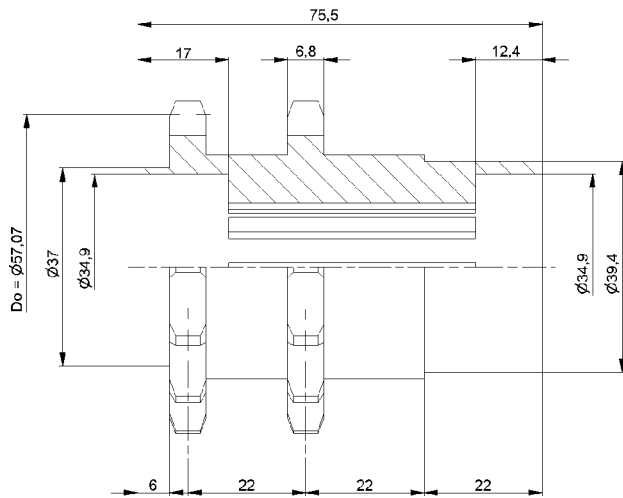

KKR-1/2" x5/16" -Z14

Other dimensions on request!

Housing: Plastic



KKR-40

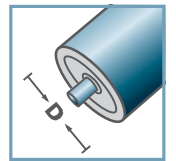

D [mm]
-

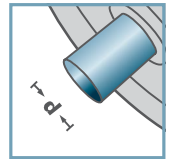

d [mm]
-



C [daN]
-

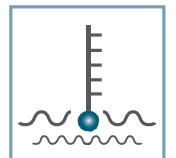

T [°C]
0° - 80°



-



Carton [pcs.]

500

Plastic Sprocket Wheel

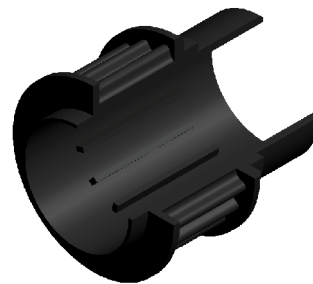
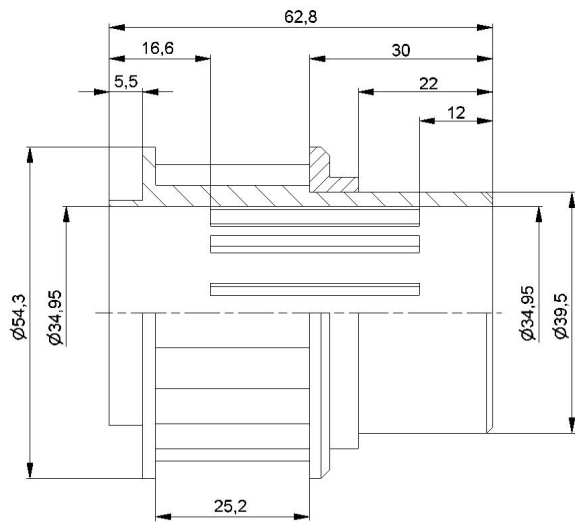

KZA-Z20.40

Other dimensions on request!

Housing: Plastic



KZA-40

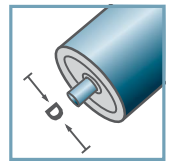

D [mm]

-

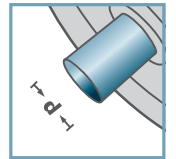

d [mm]

-



C [daN]

-

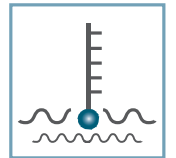

T [°C]

0° - 80°



-



Carton [pcs.]

140

Plastic Synchronous Belt Drive

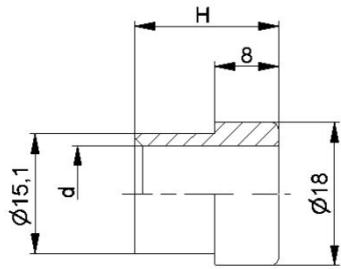

KKR-40		
	d	H
KKR-40	10	19
KKR-40	12	18
KKR-40	14	19
KKR-40	SW11	19

Other dimensions on request!

Reducing Bush: Plastic



KKR-40

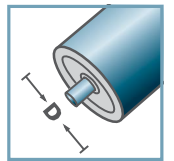

D [mm]

-

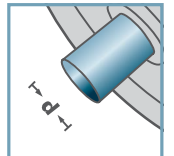

d [mm]

10; 12; 14; SW11



C [daN]

-

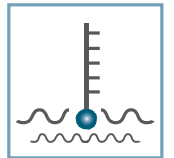

T [°C]

0° - 80°



-



Carton [pcs.]

500/8000

Reducing Bush

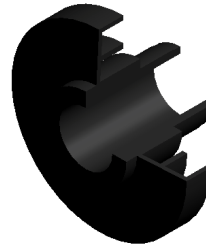
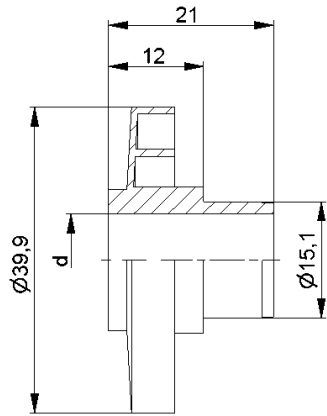

KKR-40	
Typ	d
KKR-40	10
KKR-40	12
KKR-40	14
KKR-40	SW11
Other dimensions on request!	

Labyrinth Seal: Plastic



KKR-40

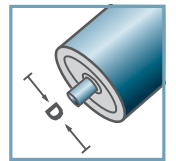

D [mm]

-

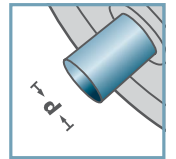

d [mm]

10; 12; 14; SW11



C [daN]

-

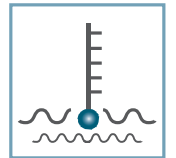

T [°C]

0° - 80°



-



Carton [pcs.]

200/1000

Labyrinth Seal

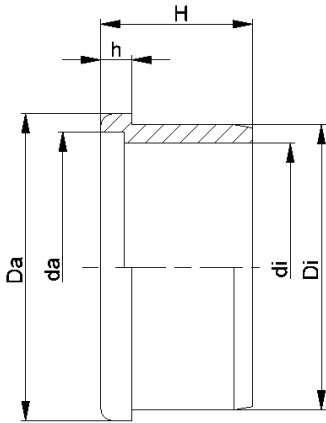

KKR-40

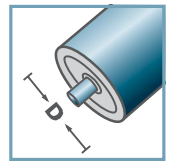

D [mm]
50 - 60

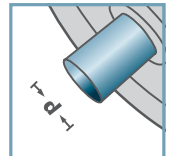

d [mm]
-



C [daN]
-

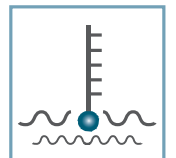

T [°C]
0° - 80°



-



Carton [pcs.]

ø50: 400
ø60: 250

KKR-40						
Typ	Di	Da	di	da	H	h
50x1,5	47,25	50	39,3	42,6	25,2	5
50x2,8	44,7	50	39,3	42,6	25,2	5
60x1,5	57,3	60	47,0	50,7	25,5	5
60x2,0	56,3	60	47,0	50,7	25,5	5

Other dimensions on request!

Distance Ring Fix: Plastic



Distance Ring Fix

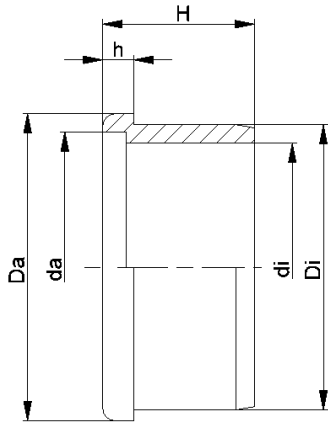

KKR-40

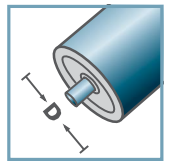

D [mm]
50 - 60

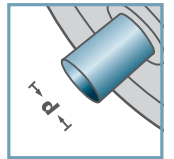

d [mm]
-



C [daN]
-

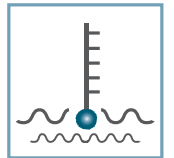

T [°C]
0° - 80°



-



Carton [pcs.]

400

KKR-40						
Typ	Di	Da	di	da	H	h
50x1,5	47,2	50	40,6	44,6	25	5

Other dimensions on request!

Distance Ring Friction: Plastic



Distance Ring Friction

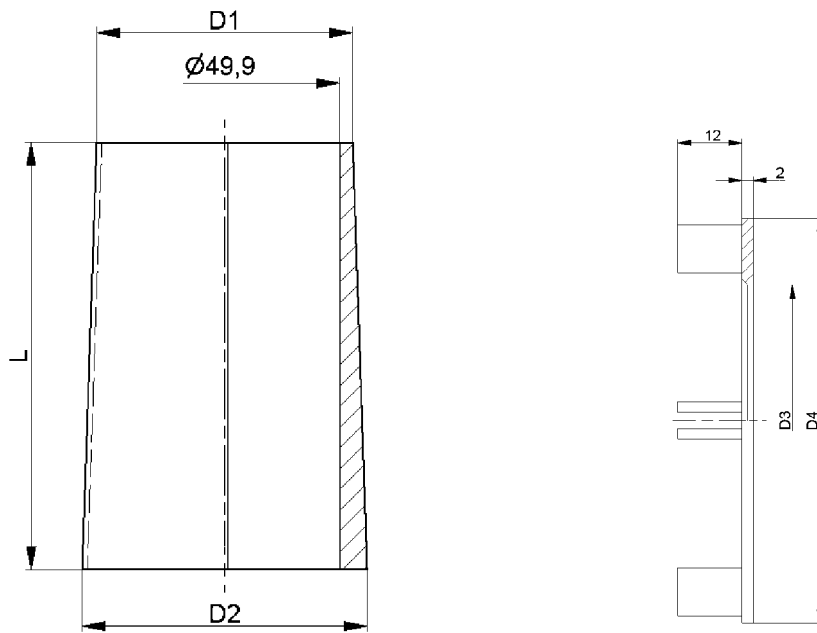

KF-50					
Type A	D1	D2	L	D3	D4
KF-50 I-a Type A	53,4	59,7	92,5	-	-
KF-50 I-b Type A	54,0	59,7	95,5	-	-
KF-50 II Type A	60,0	66,5	100,0	-	-
KF-50 III Type A	66,5	73,0	99,0	-	-
KF-50 IV Type A	73,5	80,0	100,0	50,6	75,5
KF-50 V Type A	80,0	86,5	99,5	50,7	81,7
KF-50 VI Type A	86,5	93,5	100,0	50,6	87,7
KF-50 VII Type A	93,5	100,0	100,0	50,6	94,3
KF-50 VIII Type A	100,0	106,5	95,5	-	-
KF-50 IX Type A	106,5	113,0	95,5	-	-
KF-50 X Type A	113,0	119,5	95,5	-	-

Other dimensions on request!

- ☛ Conic Roller: Plastic
- ☛ Endcap: Plastic



KF-50

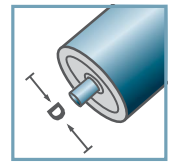

D [mm]
50

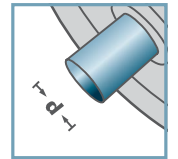

d [mm]
-



C [daN]
-

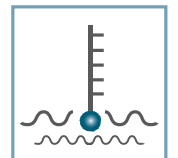

T [°C]
0° - 80°



-



Carton [pcs.]

Taper Sleeves

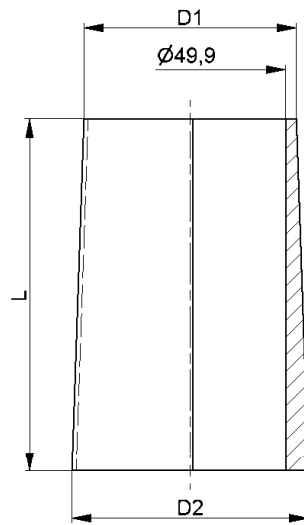

KF-50			
Type	D1	D2	L
KF-50 I Type B	54,0	59,9	90,0
KF-50 II Type B	59,9	66,6	100,0
KF-50 III Type B	66,6	73,4	100,0
KF-50 IV Type B	73,4	80,1	100,0
KF-50 V Type B	80,1	86,9	100,0
KF-50 VI Type B	86,9	93,6	100,0
KF-50 VII Type B	93,6	100,4	100,0
KF-50 VIII Type B	100,4	107,1	100,0
KF-50 IX Type B	107,1	113,9	100,0
KF-50 X Type B	113,9	120,9	100,0

Other dimensions on request!

- ☛ Conic Roller: Plastic
- ☛ Endcap: not necessary



KF-50

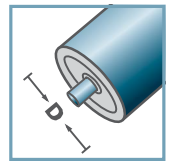

D [mm]
50

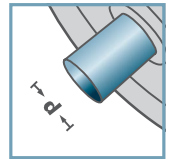

d [mm]
-



C [daN]
-

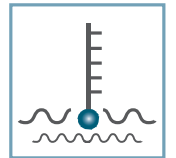

T [°C]
0° - 80°



-



Carton [pcs.]

Taper Sleeves

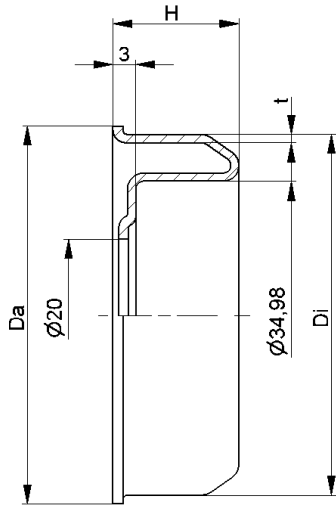

MRK-40

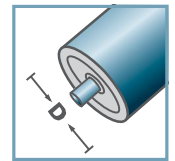

D [mm]
50 - 60

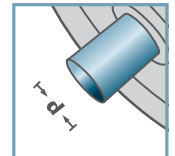

d [mm]
15

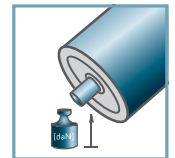

C [daN]
-

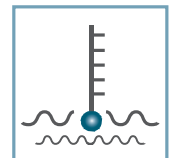

T [°C]
-



6202:
D35; d15; H11



Carton [pcs.]

MRK-40				
Type	Di ±0,1	Da	H	t
MRK-50x1,5.40	47,3	49,5	16	1,2
MRK-50x2,0.40	46,3	49,5	16	1,2
MRK-60x2,0.40	56,3	59,5	16,5	1,5
MRK-60x3,0.40	54,3	59,5	16,5	1,5

Other dimensions on request!

☛ Housing: Steel, Zinc plated



Steel Housing

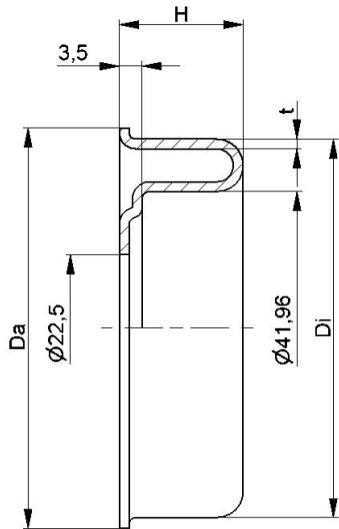

MRK-6004

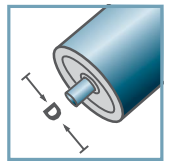

D [mm]
63,5

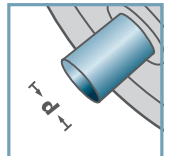

d [mm]
20



C [daN]
-

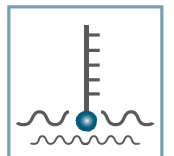

T [°C]
-



6004:
D42; d20; H12



Carton [pcs.]

MRK-6004				
Type	Di ±0,1	Da	H	t
MRK-63,5x2,9/6004	58,1	61,5	19,0	1,5

Other dimensions on request!

☛ Housing: Steel, Zinc plated



Steel Housing

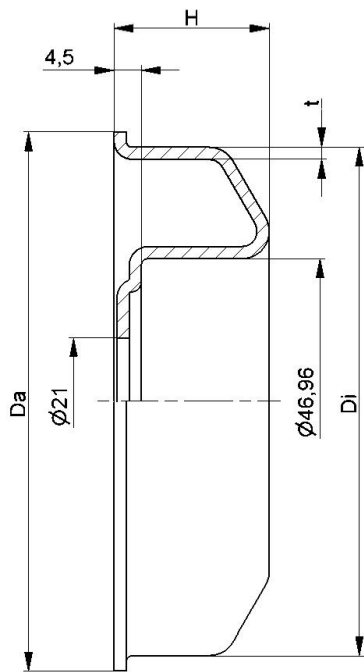

MRK-6204				
Type	Di ±0,1	Da	H	t
MRK-80x2,0/6204	76,5	79,5	23,5	2,0
MRK-80x3,0/6204	74,5	79,5	23,5	2,0
MRK-89x3,0/6204	83,5	88,5	23,5	2,0
MRK-89x3,25/6204	83,0	88,5	23,5	2,0
MRK-108x3,25/6204	102,0	107,5	25,0	2,0

Other dimensions on request!

C Housing: Steel, Zinc plated



MRK-6204

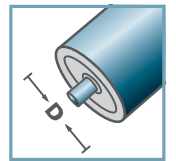

D [mm]
80 - 108

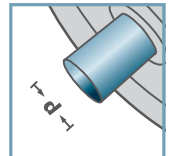

d [mm]
20



C [daN]
-

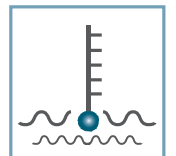

T [°C]
-



6204:
D47; d20; H14



Carton [pcs.]

Steel Housing

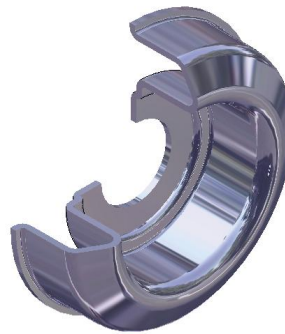
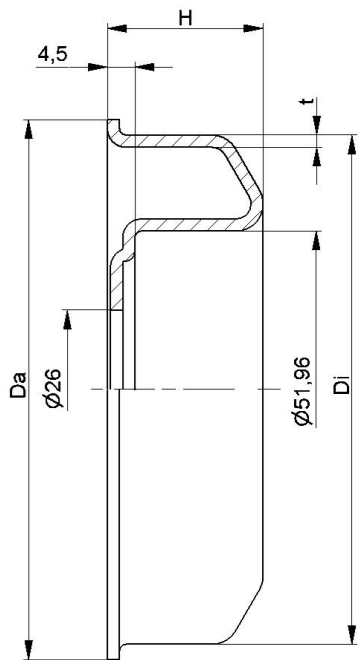

MRK-6205

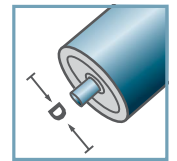

D [mm]
80 - 108

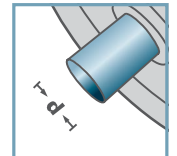

d [mm]
25



C [daN]
-

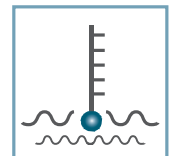

T [°C]
-



6205:
D52; d25; H15



Carton [pcs.]

MRK-6205				
Type	Di ±0,1	Da	H	t
MRK-80x3,0/6205	74,5	79,5	23,5	2,0
MRK-89x3,0/6205	83,5	88,5	24,5	2,0
MRK-108x3,25/6205	102,0	107,5	25,5	2,0

Other dimensions on request!

☛ Housing: Steel, Zinc plated



Steel Housing