

KTS-30			
Typ	Di +0,2	Da	Tragzahl C [daN]
KTS-50x1,5.30	47,3	49,9	80
KTS-50x2,8.30	44,6	49,9	80
KTS-60x1,5.30	57,3	59,9	80

Weitere Varianten auf Anfrage!

- ☛ Radkörper: Kunststoff
- ☛ Einfachlabyrinth: Kunststoff
- ☛ Kugellager RL-30
 - ☛ Lagerschale: Stahl, gehärtet
 - ☛ Innenring: Stahl, gehärtet
 - ☛ Kugelförmig: Kunststoff
 - ☛ Kugel: Stahl

Achtung: bei Achse 15 mm ist das Einfachlabyrinth lose beigelegt und muss bei der Montage gesichert werden!

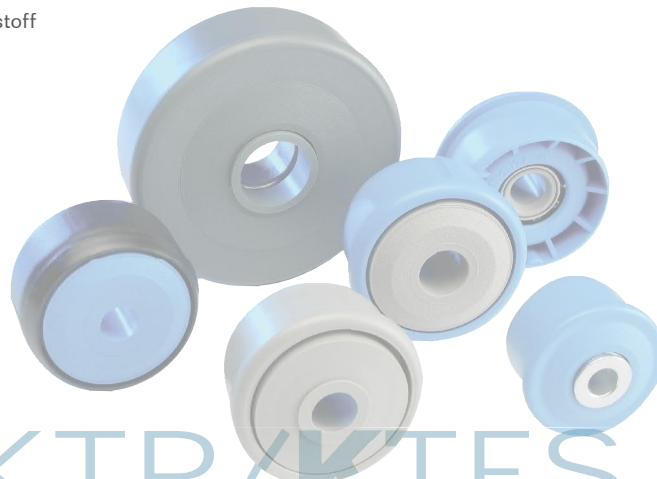

KTS-30

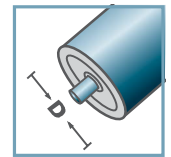

D [mm]
50 - 60

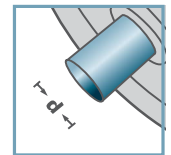

d [mm]
10; 12; 15; SW11



C [daN]
80

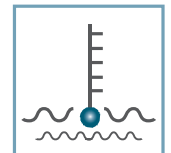

T [°C]
0° - 80°



Öl



Karton [Stck.]

ø50: 250
ø60: 200

KTS/KTR/KTES

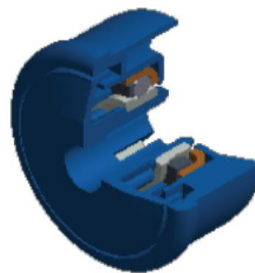
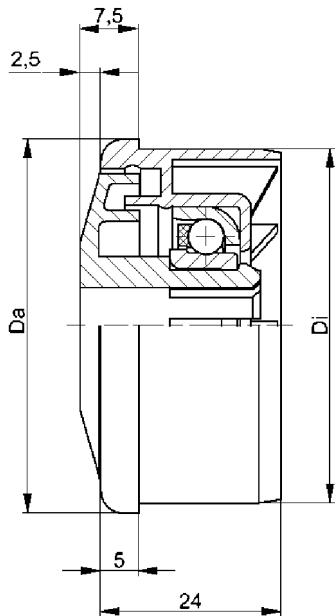

KTS-31			
Typ	Di +0,2	Da	Tragzahl C [daN]
KTS-50x1,5.31	47,3	49,9	25
KTS-50x2,8.31	44,6	49,9	25
KTS-60x1,5.31	57,3	59,9	25

Weitere Varianten auf Anfrage!

- ☛ Radkörper: Kunststoff
- ☛ Einfachlabyrinth: Kunststoff
- ☛ Kugellager RL-31
 - ☛ Lagerschale: 1.4301
 - ☛ Innenring: 1.4305
 - ☛ Kugelkäfig: Kunststoff
 - ☛ Kugel: 1.4301

Achtung: bei Achse 15 mm ist das Einfachlabyrinth lose beigelegt und muss bei der Montage gesichert werden!

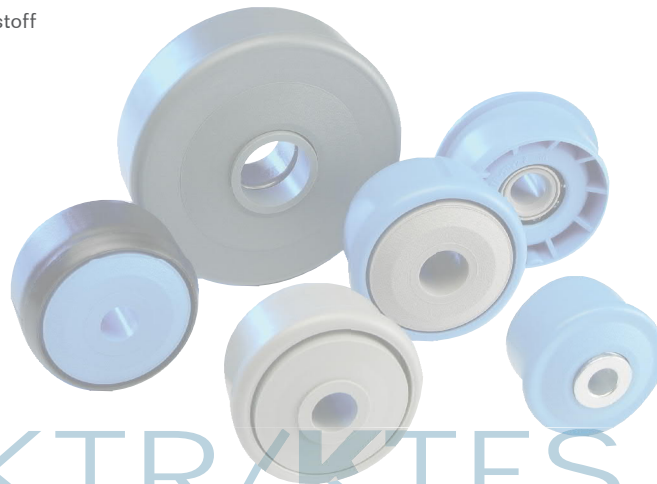

KTS-31

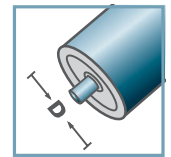

D [mm]
50 - 60

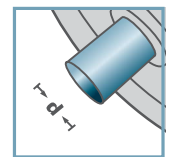

d [mm]
10; 12; 15; SW11



C [daN]
25

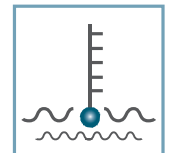

T [°C]
0° - 80°



Öl



Karton [Stck.]

ø50: 250
ø60: 200

KTS/KTR/KTES

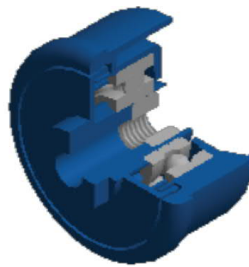
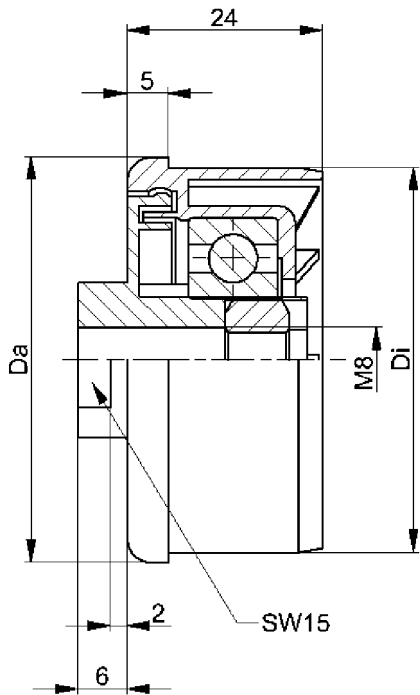

KTR-40.M8			
Typ	Di +0,2	Da	Tragzahl C [daN]
KTR-50x1,5.40	47,3	49,9	80

Weitere Varianten auf Anfrage!

- Radkörper: Kunststoff
- Einfachlabyrinth: Kunststoff
- Kugellager 6202
- Sechskantmutter

KTR-40.M8

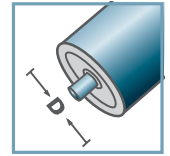

D [mm]
50

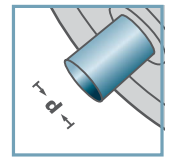

d [mm]
M8



C [daN]
80

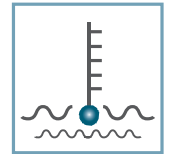

T [°C]
0° - 80°



EP 2



Karton [Stck.]

ø50: 250

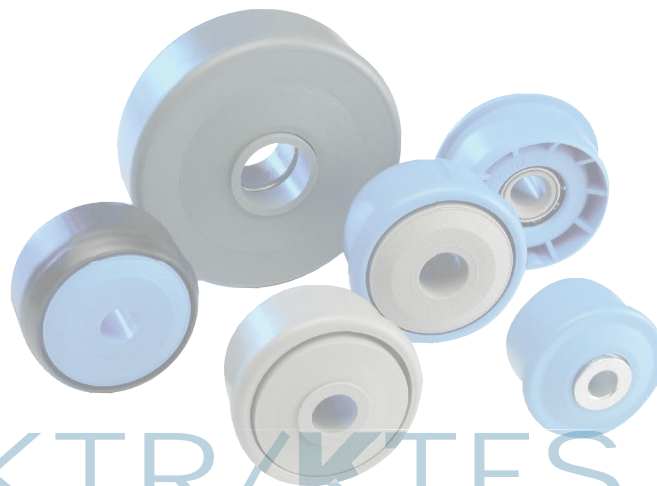

KTS/KTR/KTES

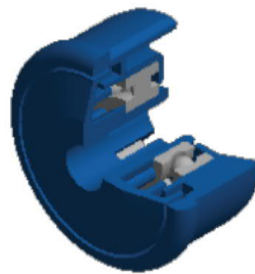
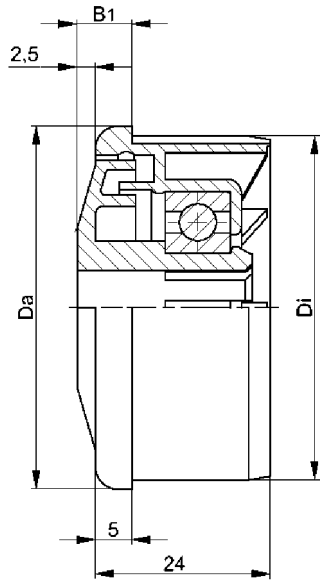

KTS-42				
Typ	Di +0,25	Da	B1	Tragzahl C [daN]
KTS-40x1,5.42	37,2	39,9	9,0	120
KTS-50x1,5.42	47,3	49,9	7,5	80
KTS-50x2,0.42	46,3	49,9	7,5	80
KTS-50x2,8.42	44,6	49,9	7,5	80
KTS-60x1,5.42	57,3	59,9	7,5	80
KTS-60x2,0.42	56,3	59,9	7,5	80
Weitere Varianten auf Anfrage!				

- 🔩 Radkörper: Kunststoff
- 🔩 Einfachlabyrinth: Kunststoff
- 🔩 Kugellager 6002

Achtung: bei Achse 15 mm ist das Einfachlabyrinth lose beigelegt und muss bei der Montage gesichert werden!



KTS-42

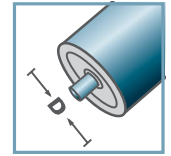

D [mm]
40 - 60

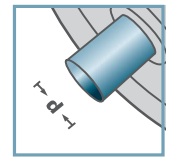

d [mm]
10; 12; 15; SW11



C [daN]
80; 120

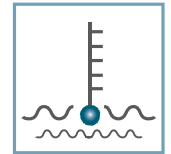

T [°C]
0° - 80°



EP 2



Karton [Stck.]

ø40: -
ø50: 250
ø60: 200

KTS/KTR/KTES

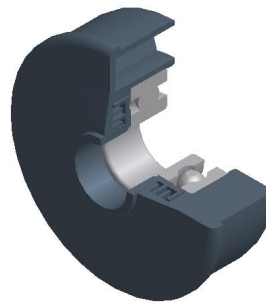
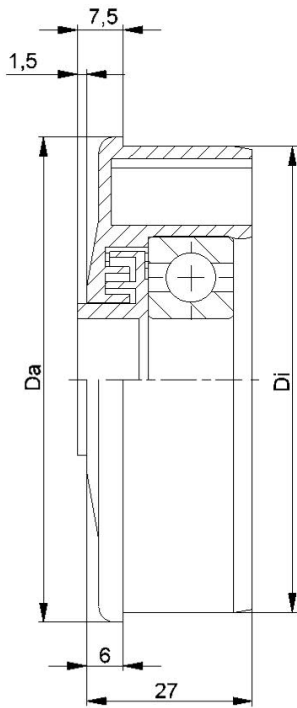

KTR-43/44			
Typ	Di +0,2	Da	Tragzahl C [daN]
KTR-63,5x2,9.43/.44	58,0	63,4	150
KTR-80x2,0.43/.44	76,4	79,9	150

Weitere Varianten auf Anfrage!

- Radkörper: Kunststoff
- Mehrfachlabyrinth: Kunststoff
- Kugellager 6303/6204

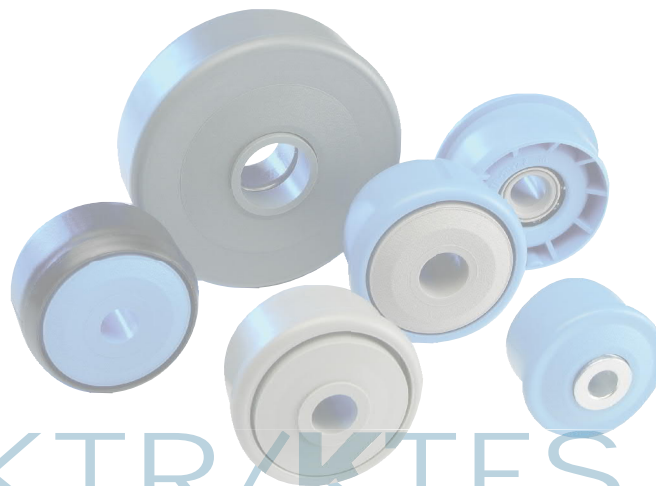

KTR-43/44

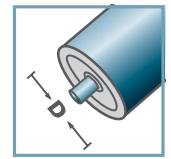

D [mm]
63,5 - 80

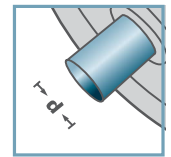

d [mm]
6303: 17
6204: 20



C [daN]
150

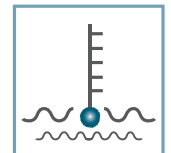

T [°C]
0° - 80°



EP 2



Karton [Stck.]

100

KTS/KTR/KTES

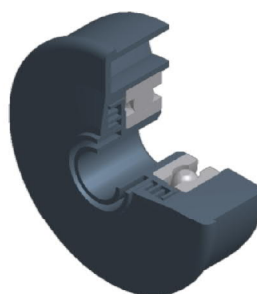
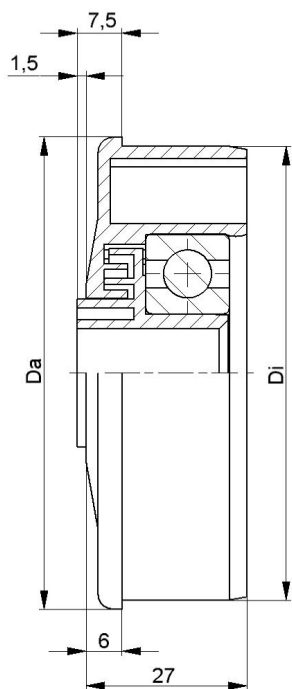

KTR-44			
Typ	Di +0,2	Da	Tragzahl C [daN]
KTR-63,5x2,9.44	58,0	63,4	150
KTR-80x2,0.44	76,4	79,9	150

Weitere Varianten auf Anfrage!

- ☛ Radkörper: Kunststoff
- ☛ Mehrfachlabyrinth: Kunststoff
- ☛ Kugellager 6303/6204

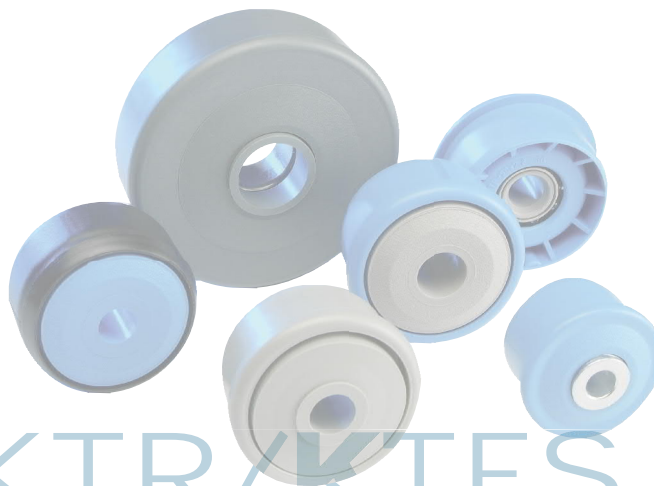

KTR-44

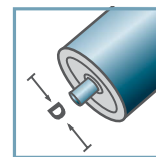

D [mm]
63,5 - 80

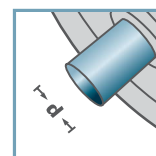

d [mm]
15

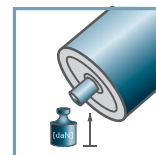

C [daN]
150

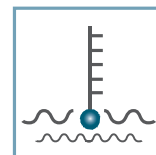

T [°C]
0° - 80°



EP 2



Karton [Stck.]

100

KTS/KTR/KTES

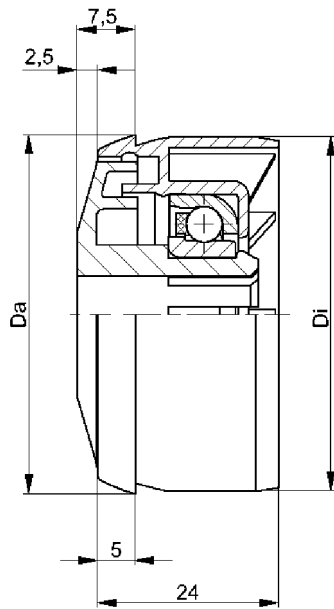

KTES-30			
Typ	Di +0,3	Da	Tragzahl C [daN]
KTES-50x1,5.30	47,1	47,9	80

Weitere Varianten auf Anfrage!

- ☛ Radkörper: Kunststoff
- ☛ Einfachlabyrinth: Kunststoff
- ☛ Kugellager RL-30
 - ☛ Lagerschale: Stahl, gehärtet
 - ☛ Innenring: Stahl, gehärtet
 - ☛ Kugelförmig: Kunststoff
 - ☛ Kugel: Stahl

Achtung: bei Achse 15 mm ist das Einfachlabyrinth lose beigelegt und muss bei der Montage gesichert werden!

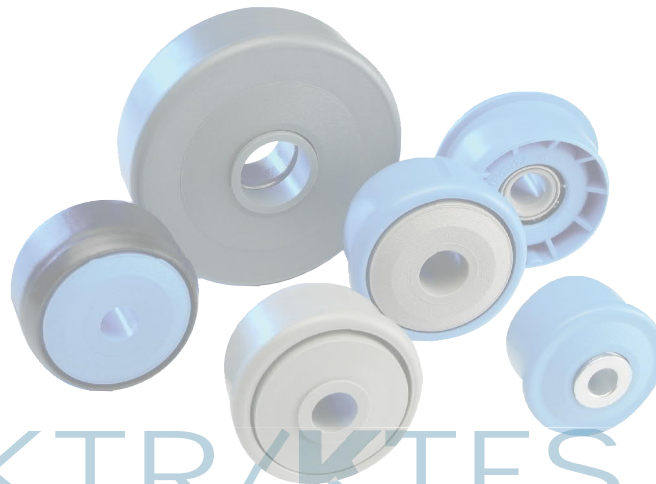

KTES-30

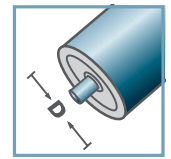

D [mm]
50

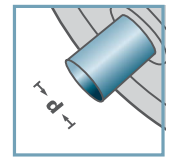

d [mm]
10; 12; 15; SW11



C [daN]
80

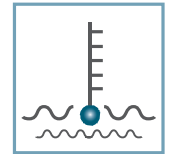

T [°C]
0° - 80°



Öl



Karton [Stck.]

250

KTS/KTR/KTES

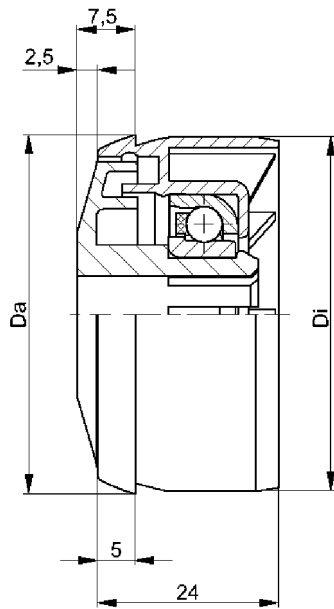

KTES-31			
Typ	Di +0,3	Da	Tragzahl C [daN]
KTES-50x1,5.31	47,1	47,9	25

Weitere Varianten auf Anfrage!

- ☛ Radkörper: Kunststoff
- ☛ Einfachlabyrinth: Kunststoff
- ☛ Kugellager RL-31
 - ☛ Lagerschale: 1.4301
 - ☛ Innenring: 1.4305
 - ☛ Kugelhäufig: Kunststoff
 - ☛ Kugel: 1.4301

Achtung: bei Achse 15 mm ist das Einfachlabyrinth lose beigelegt und muss bei der Montage gesichert werden!

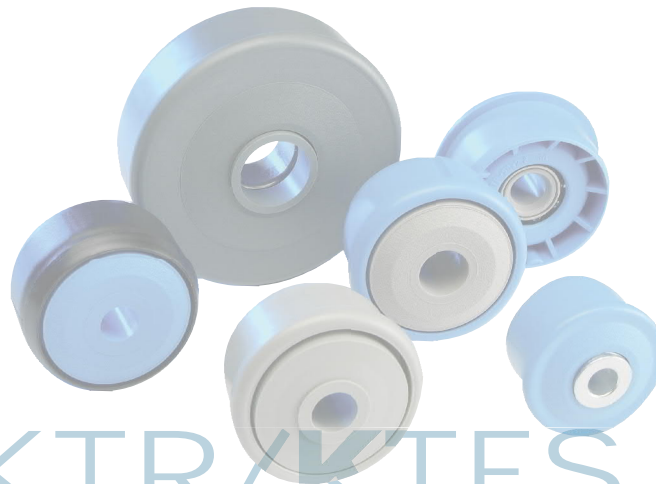

KTES-31

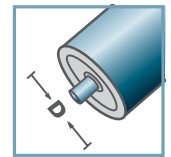

D [mm]
50

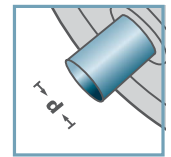

d [mm]
10; 12; 15; SW11



C [daN]
25

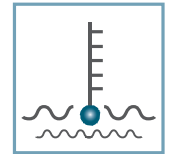

T [°C]
0° - 80°



Öl



Karton [Stck.]

250

KTS/KTR/KTES

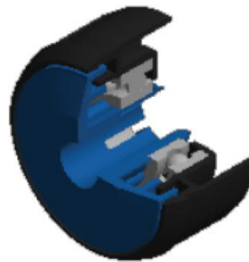
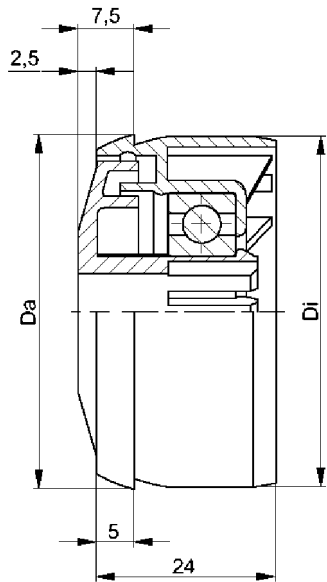

KTES-42			
Typ	Di +0,3	Da	Tragzahl C [daN]
KTES-50x1,5.42	47,1	47,9	80

Weitere Varianten auf Anfrage!

- ☛ Radkörper: Kunststoff
- ☛ Einfachlabyrinth: Kunststoff
- ☛ Kugellager 6002

Achtung: bei Achse 15 mm ist das Einfachlabyrinth lose beigelegt und muss bei der Montage gesichert werden!

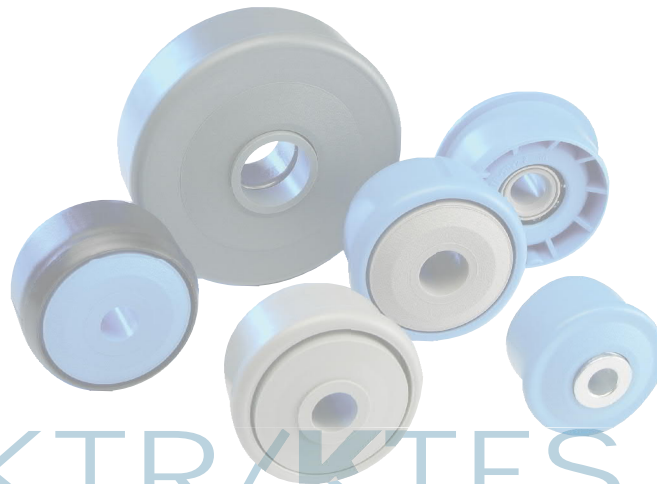

KTES-42

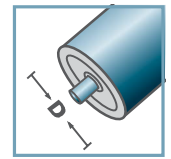

D [mm]
50

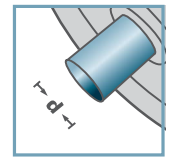

d [mm]
10; 12; 15; SW11



C [daN]
80

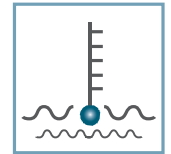

T [°C]
0° - 80°



EP 2



Karton [Stck.]

250

KTS/KTR/KTES